

# SCREEN RECORDER KD7



USER'S MANUAL



## Contents

<b>1.</b>	<b>INTRODUCTION.....</b>	<b>4</b>
1.1	Recorder applications .....	4
1.2	Recorder features .....	4
<b>2.</b>	<b>GENERAL INFORMATION.....</b>	<b>5</b>
2.1	Warning and information signs .....	5
2.2	Safety of service .....	5
2.2.1	Remarks concerning the recorder installation.....	5
2.2.2	Precautions in the scope of ESD protection.....	6
<b>3.</b>	<b>RECORDER PREPARATION TO WORK.....</b>	<b>6</b>
3.1	Unpacking .....	6
3.2	Installation in a panel .....	8
3.3	Operating conditions of the recorder.....	8
<b>4.</b>	<b>RECORDER CONSTRUCTION.....</b>	<b>8</b>
4.1	LCD screen with touch panel .....	9
4.2	CompactFlash memory card, USB interface, LED diode.....	10
4.3	Terminal plate .....	12
4.3.1	Connection of analog signals.....	13
4.3.1.1	Standard measuring systems AI 1..12.....	13
4.3.1.2	Programmable measuring systems AI 1..12.....	13
4.3.1.3	Analog output systems AO 1..8.....	14
4.3.2	Connection of digital signals.....	15
4.3.2.1	Alarm systems AL 1..32 and binary inputs BI 1..16 .....	15
4.3.2.2	Interfaces RS485(1), RS485(2), RS232, Ethernet 10-Base-T .....	16
4.3.3	Recorder supply .....	17
<b>5.</b>	<b>GRAPHICAL SIGNS ON THE RECORDER SCREEN .....</b>	<b>17</b>
5.1	Status bar .....	17
5.2	Measuring views.....	17
5.3	Service menu .....	18
5.4	Information messages. ....	18
5.5	Dialogues.....	19
<b>6.</b>	<b>STARTING THE RECORDER.....</b>	<b>19</b>
6.1	Context menu .....	20
6.2	Entry into the recorder parameter configuration, “KD7 control panel “ window.....	22
<b>7.</b>	<b>CONFIGURING THE RECORDER.....</b>	<b>23</b>
7.1	General settings .....	24
7.2	Ethernet .....	25
7.3	Modbus .....	25
7.4	Safety.....	26
7.5	System information .....	27
7.6	Alarm and analog outputs .....	28
7.7	CF card.....	29
7.8	Configuration, visualization and archiving of the channel group.....	30
7.9	Context menu .....	31
7.10	Inputs (logic channels).....	32
7.10.1	Definition of logic channel .....	33
7.10.2	Menu of logic channel programming .....	35
7.10.3	Selection and configuration of the input for a logic channel.....	37
7.10.3.1	Modbus Master Input CI 1..24 .....	37
7.10.3.2	Analog input AI 1..16.....	39
7.10.3.3	Mathematical functions MT 1..16, activation of the access.....	43
7.10.3.4	Binary input BI 1..16 .....	49
7.10.3.5	Alarm of the logic channel 1..32.....	50
7.10.3.6	Totalizer of the logic channel 1..32.....	50
7.11	Configuration and service of event logs.....	51
7.11.1	Review and service of event logs.....	52

7.11.2	Programming of event logs.....	53
7.12	Edition of operator messages.....	55
7.13	Exit from the recorder configuration.....	57
<b>8.</b>	<b>SELECTED ELEMENTS OF THE RECORDER CURRENT SERVICE.....</b>	<b>58</b>
8.1	CompactFlash memory card .....	58
8.1.1	Information about the CF memory card.....	58
8.1.2	Formatting the CF card.....	58
8.1.3	Data storage on the CF card (card storage capacity).....	59
8.1.4	Visualization of the CF card state on the screen .....	61
8.1.5	Review and erasing of files from the CF card.....	61
8.1.6	Removal/replacement of the CF card, storage of archive data.....	62
8.2	Programming of logic channel groups 1...4 .....	63
8.2.1	Programming group parameters .....	64
8.2.2	Digital view of the channel group.....	66
8.2.3	Linear chart of the channel group.....	67
8.2.4	View of the channel group in the form of bargraphs .....	69
8.2.5	Analog view of the channel group.....	70
8.2.6	Statistic view of the channel group.....	71
8.2.7	Enabling/Disabling of the screen automatic switching in the group.....	72
8.2.8	Zoom scale function of the signal (measuring magnifier).....	73
8.3	Selection of the measuring data file format (digital signature).....	74
8.4	Structure of the data flow in KD7 recorder.....	75
8.5	Programming logic channel parameters.....	77
8.5.1	Programming General, Visualization and Common parameters.....	77
8.5.2	Programming the Logic channel alarm.....	79
8.5.3	Programming Totalizer parameters (Counter/Integral).....	83
8.5.4	Programming of parameters (Common).....	86
8.5.5	Totalizer control ( Counter/Integral).....	87
8.6	Programming outputs.....	88
8.6.1	Programming analog outputs.....	88
8.6.2	Programming alarm outputs.....	88
8.7	Edition of recorder users .....	90
8.8	Review of archived data .....	91
8.9	Calibration of the touch screen.....	92
8.10	Updating of the recorder software.....	93
8.11	Service of data stored on the CF card, visualization.....	94
<b>9.</b>	<b>PROGRAMS ON PC.....</b>	<b>95</b>
9.1	KD Connect program.....	95
9.1.1	Installation of drivers for the KD7 recorder .....	95
9.1.2	Installation of the KD Connect program .....	96
9.1.3	Program service.....	98
9.1.4	Example of using the KD Connect program .....	102
9.1.5	Error messages.....	104
9.2	KD7 Setup program.....	104
9.2.1	Installation.....	104
9.2.2	Program service.....	105
9.3	KD Check program .....	107
9.4	KD Archive program.....	108
9.5	Service of the WWW server .....	108
9.5.1	General view.....	109
9.5.2	View of the window to browse data from the CF card .....	109
9.5.3	View of the window with information about the KD7 recorder.....	110
9.5.4	Configuration.....	110
9.5.5	Symbols of the KD7 recorder on the web page.....	111
9.5.6	Firmware update thru the device web page .....	111
9.5.7	FTP Download Application .....	113
<b>10.</b>	<b>TECHNICAL DATA .....</b>	<b>114</b>
<b>11.</b>	<b>ORDER CODES.....</b>	<b>118</b>
<b>12.</b>	<b>MAINTENANCE AND GUARANTEE.....</b>	<b>119</b>

## 1. INTRODUCTION

### 1.1 RECORDER APPLICATIONS

The KD7 screen recorder is applied as a data acquisition station in measuring and control systems. It finds application to measure, visualize and supervise technical process parameters in various industrial branches, e.g. pharmacy, food, chemical and papermaking industries.

It can be also used as an autonomous measuring and recording device.

The KD7 screen recorder is adapted to measure voltage, current, temperature, resistance changes and other quantities converted into a signal or electrical parameter. The source of measuring data can be also communication interfaces (ETHERNET, RS-485).

All processes suitable for a measuring system can be realized in this recorder: measurement of input signals and their conversion, visualization and archiving of data, signaling and communication with the environment.

Converted measuring data are stored in the internal memory and on the CompactFlash card.

### 1.2. RECORDER FEATURES

- LCD TFT 5.7" colour screen, 320 x 240 pixels, with a touch panel for the recorder service,
- Exchangeable CompactFlash internal memory with capacity from 16 MB up to 4 GB,
- Communication interfaces: Ethernet 10 Base-T, USB 1.1 Device, RS-485 Modbus Slave and Master, RS-232,
- Measuring inputs for the direct connection of thermocouples, voltage, current and resistance,
- Analog outputs, alarms, binary inputs,
- Mathematical functions, counters and totalizers, operator messages.
- Digital signature for archived data, stored in textual or binary format,
- Visualization and archiving of measuring data transmitted to the recorder from other devices through the RS-485 Modbus Master interface or Ethernet,
- Linearization of sensor characteristics,
- Programmable current, voltage and resistance inputs,
- Copying of parameter setting between channels,
- Programming of recorder parameters,
- Programming of screens and choice of screen configurations,
- Storage of data in the internal 6 MB buffer with data support (for before damage and after damage states)
- Structure programming of functions converting measuring quantities into output quantities and structures of alarm functions, destined to be exposed on the screen and written on the data carrier,
- Determination of the set of data for the current exposition on the screen,
- Choice of the time zone, automatic change of summer/winter time, synchronization with a time server.

**Note: The update for the KD7 recorder software is available on the page:**  
**<http://www.lumel.com.pl>**

## 2. GENERAL INFORMATION

### 2.1 Warning and information signs

One or more of presented symbols can be used in the recorder.



**Caution:** one must pay attention to the description in the recorder user's manual.



Terminal of the protection lead



Earth terminal



Protection of sensitive electrostatic systems (ESD)

### 2.2 Safety of service

The KD7 recorder fulfils requirements related to safety of electrical measuring instruments for automation, acc. to EN 61010-1 standard and requirements concerning the resistance against interference occurring in industrial environment acc. to EN 61000-6-2 and EN 61000-6-4 standards. The connection of supply, communication interfaces and measuring signals, and the use of equipment inconsistent with the description included in the present user's manual and standards as above can cause serious weakening of the recorder protection against interference.

A switch or a circuit - breaker should be located near the device, easy accessible by the operator and suitable marked.

#### 2.2.1 Remarks concerning the recorder installation

Various sources of interference occurring in practice, interact with the recorder in a continuous or impulse way from the supply network side (as the result of the action of other devices) and also overlap on the measured signal or auxiliary circuits of the recorder.

In particular, strong impulse interference is dangerous for the operation of devices since they can cause sporadic erroneous measurement results or accidental operations of alarms, despite of the use of suitable filters in the recorder. The level of this interference should be reduced to a value lower than the resistance threshold of the recorder, first of all through a suitable installation of the recorder in the object.

**In this scope, it is recommended to observe following recommendations:**

- Do not supply recorders from networks near devices generating high impulse interference in the supply network and do not use common grounding circuits with them,
- Use network filters for the group of recorders servicing the same object,
- Use metallic shields in the shape of tubes or braids to lead supplying wires (phase, zero), in which one can also lead the earth conductor and eventually network wires supplying contacts of alarm relays of the given recorder,

- Lead individually connections of binary input circuits in shields as above, by means of twisted wires,
- Lead individually connections of communication interface circuits in shields as above and by means of twisted wires,
- Wires leading measuring signals for each measuring recorder channel should be twisted in pairs, and for resistance sensors in 3-wire connection, twisted of wires of the same length, cross-section and resistance, and led in shields as above. Wires leading measuring signals to the same recorder can be led in the same shield ( if it is possible),
- All shields should be earthed unilaterally near the recorder,
- One must avoid a common earth conductor with other devices,
- Apply the general principle, that wires (group of wires) leading different signals should be led in the longest possible distance between them and crossings of such groups of wires made at a 90° angle,
- Set on the supply cable (near the recorder) a ferrite filter STAR-TEC 74271132 being in the recorder accessory set.

### 2.2.2. Precautions in the scope of ESD protection



Semiconductor elements or packages used in the recorder design and marked with the sign as above, can become damaged in result of electrostatic discharges (ESD).

**In order to prevent this, one must observe following recommendations during service works.**

- Disassemble instruments only in the area protected against electrostatic discharges,
- Use conductive materials to dissipate electrostatic charges in the working area,
- Use only antielectrostatic packings to store electronic elements and packages,
- Do not touch elements and packages with hands,
- Do not keep materials susceptible to generate electrostatic charges in the working area.



***CAUTION: Repairs and modifications in the recorder equipment should be carried out by authorized service workshops or with the manufacturer.***

### 3. RECORDER PREPARATION TO WORK

The recorder with accessories is delivered in packing fulfilling requirements of environment protection regulations.

The recorder in the packing can be transported and stored in the temperature:  
-20 ....+60°C (-4 ...140°F).

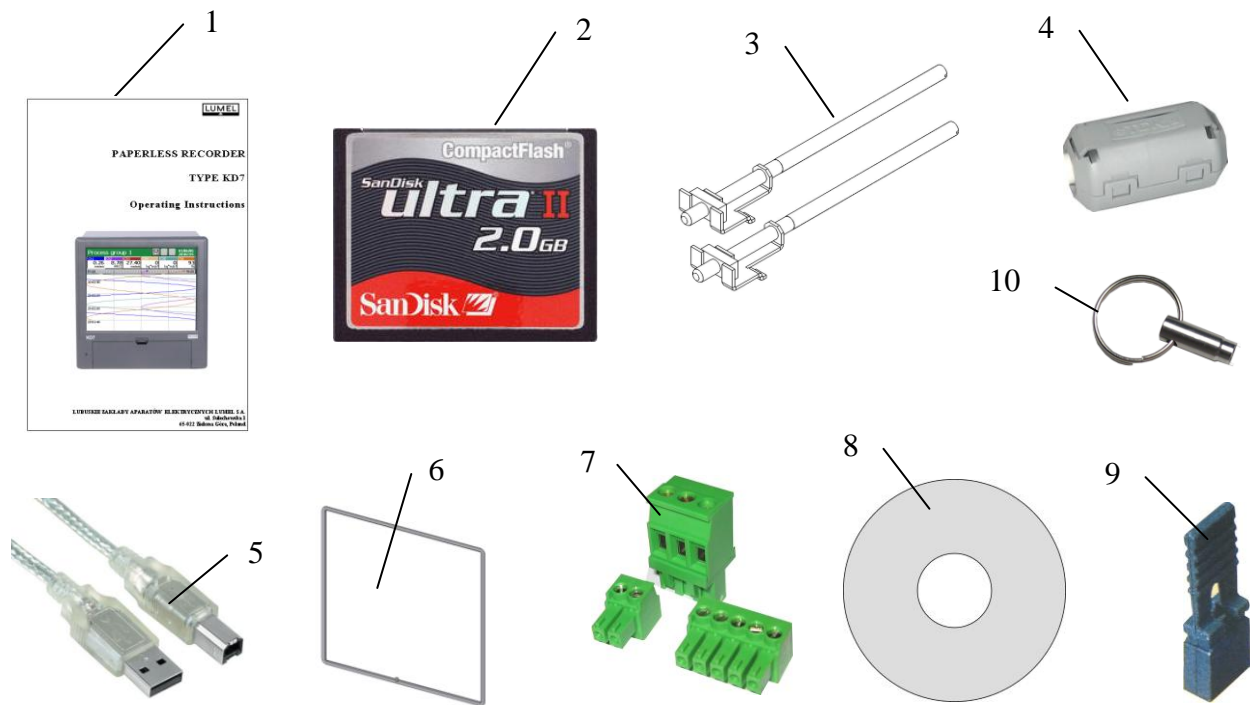
### 3.1 Unpacking

- Take the KD7 recorder out from the shipping packing

The data plate with the version code, factory number and supply parameters is placed on the recorder housing. Before unpacking, check the conformity of the recorder version with the order.



- Take recorder accessories out from the packing.

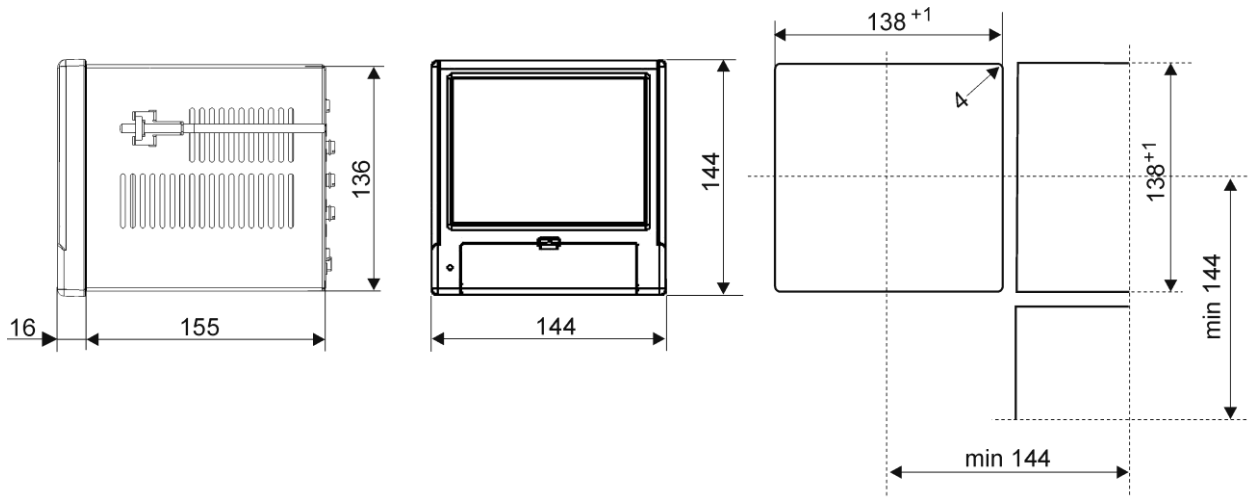


- |  |             |
|--|-------------|
| 1. User's manual (printed version or on a CD disk) | 1 pc        |
| 2. CF 4 GB memory card or other 1)                 | 1 pc        |
| 3. Mounting brackets                               | 4 pcs       |
| 4. Ferrite core                                    | 1 pc        |
| 5. USB cable 1.8m (shielded)                       | 1 pc        |
| 6. Seal (KD7 housing– panel)                       | 1 pc        |
| 7. Set of plugs <sup>2)</sup>                      | 1 set       |
| 8. CDR disk <sup>3)</sup>                          | 1 pc        |
| 9. Current test links <sup>4)</sup>                | 6 or 12 pcs |
| 10. Key  | 2 pcs       |
| 11. Guarantee card                                 | 1 pc        |

1) Or other, according to ordered CompactFlash card with capacity up to 4GB.  
 2) The set is accommodated to the ordered recorder version

- 3) Following documents are recorded on the CDR: user's manual of the KD7 recorder, **KD CONNECT** program for the communication with KD7 through the USB interface, **KD CHECK** program to check the digital signature in archive files, USB drivers for the KD7 recorder and, according to the order version, **KD7 SETUP** and **KD ARCHIVE** programs with user's manuals to service these programs.
- 4) Current test links are added to accessories for the KD7 version with programmable measuring systems.

### 3.2 Installation in a panel



Put the seal from standard accessories on the housing (see section 3.1.). After mounting the recorder into the panel, the seal protects the part behind the panel against the influence of risks appearing from the frontal part of the panel, resulting from the IP65 protection degree.

The recorder is fixed to the panel by means of four screwed mounting brackets from the recorder accessories (see section 3.1.).

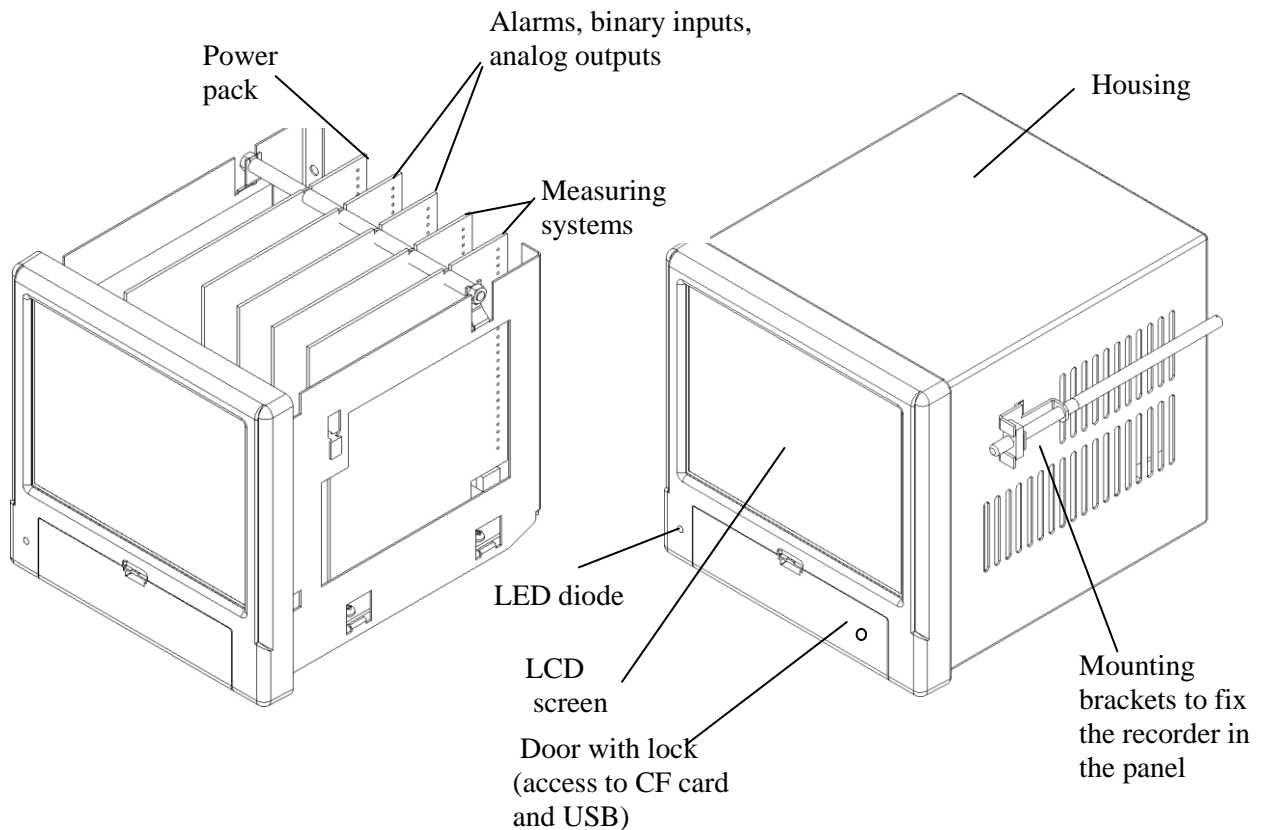
Basic fixing and panel cut-out dimensions are presented above.

### 3.3. Operating conditions of the recorder

The recorder can work at ambient temperature: 0...+50°C (32 ...122°F) and max.75% of relative air humidity without condensation.

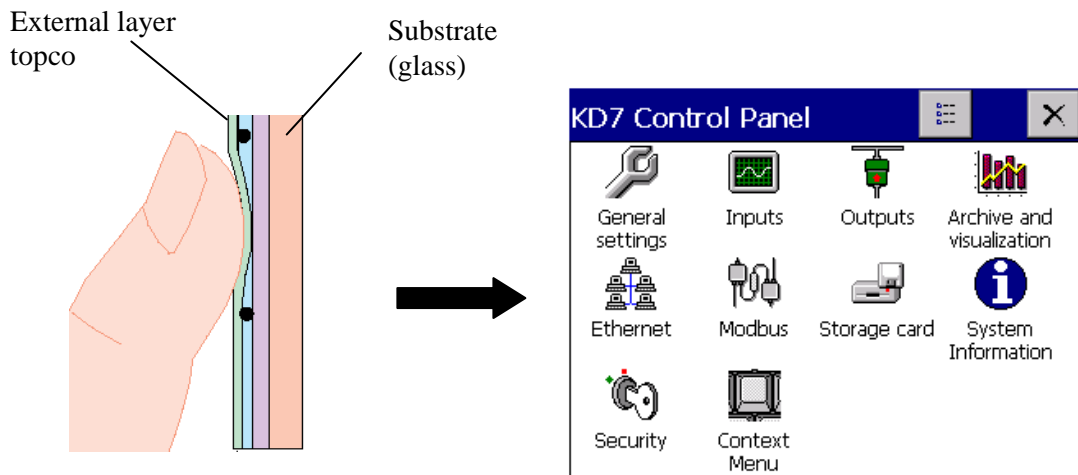


## 4. RECORDER CONSTRUCTION



### 4.1. LCD screen with touch screen

For the visualization of measuring data and the configuration of recorder parameters, an LCD TFT 5,7" graphical screen integrated with the touch screen is applied.



All elements of the user's interface (windows, icons, buttons) have dimensions adapted to be serviced by fingers – They do not require special tools.

After installing the recorder into the panel, remove the foil protecting the external flexible layer of the touch screen from the LCD screen.

Considering the sensibility of the touch screen to dirt and external damages of its surface and the substrate, one must observe following recommendations:

- protect against surges, they can damage the external surface or the glass substrate of the touch screen,
- protect against fluids, grease and aggressive chemical agents,
- touch only with fingers, do not use hard and sharp objects which can damage the flexible surface of the touch screen,
- clean softly with a cotton cloth impregnated with a detergent destined to clean LCD monitors (not containing alcohol, petrol or ammonia ) or by using water with soap,
- observe the given temperature range of the recorder operation.

Since there is the possibility of a memory effect symptom occurrence on screens of LCD type (after a prolonged display of a constant figure), the blanking of the screen after a 15-minute continuous work is set in the recorder as a standard, without touching the screen.

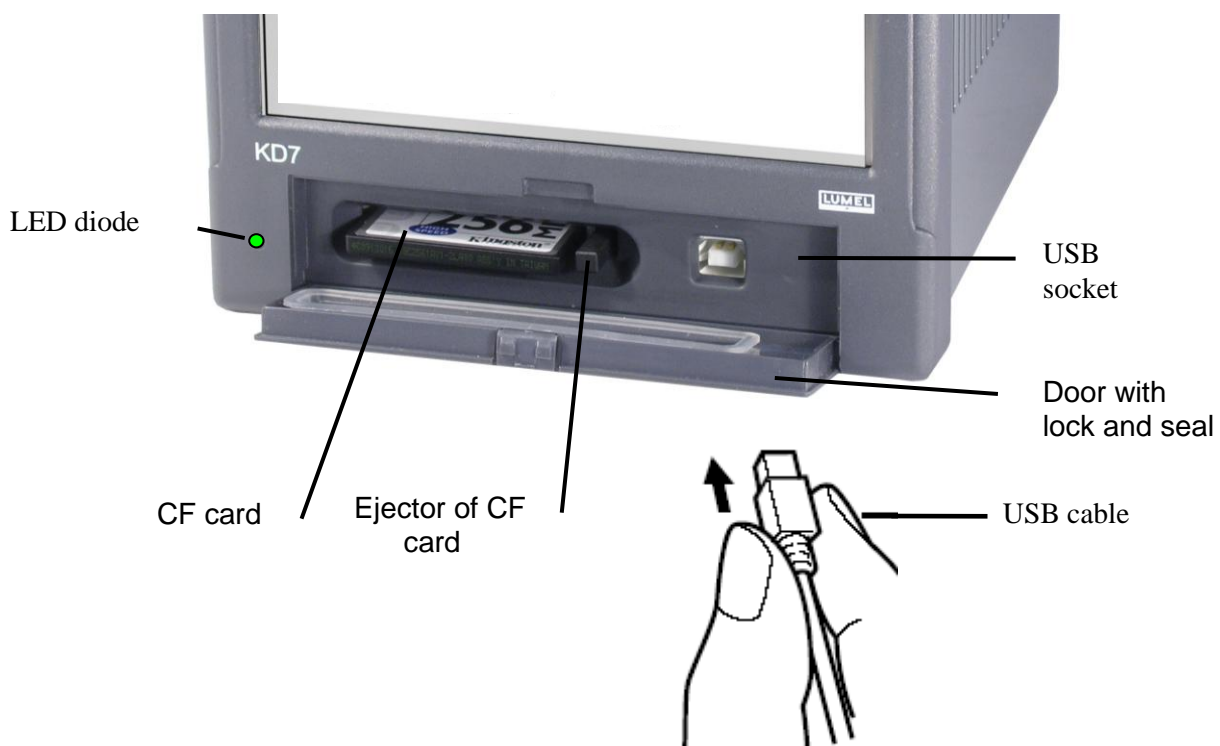
The renewed activation of the screen follows after touching it.

The blanking time can be changed or this function can be turned off ( see section 7.1)

#### 4.2. CompactFlash memory card, USB interface, LED diode

A CompactFlash card with capacity up to 4 GB is foreseen for the measuring data storage in the KD7 recorder.

Current measuring data, archive data and recorder configuration files are stored on the CF card



*Fig. Frontal view of the recorder after opening the door*

One can upload data stored on the CF card to a PC and record or erase files on the CF card through the USB interface.

To connect the computer to the recorder through USB socket, use delivered in standard accessories, the shielded USB AM-BM cable of 1.8 m long or another similar one of 5 m long ( the USB bus operates correctly without amplification at the distance up to 5 m).

In order that the KD7 recorder was seen in a PC with MS Windows operating system and serviced through USB, one must install drivers and the **KD Connect** program from the delivered CDR being in the recorder accessories (for description and program installation (see section 9.1 ) .

The LED diode placed on the left side of the door signals the recorder operating conditions:

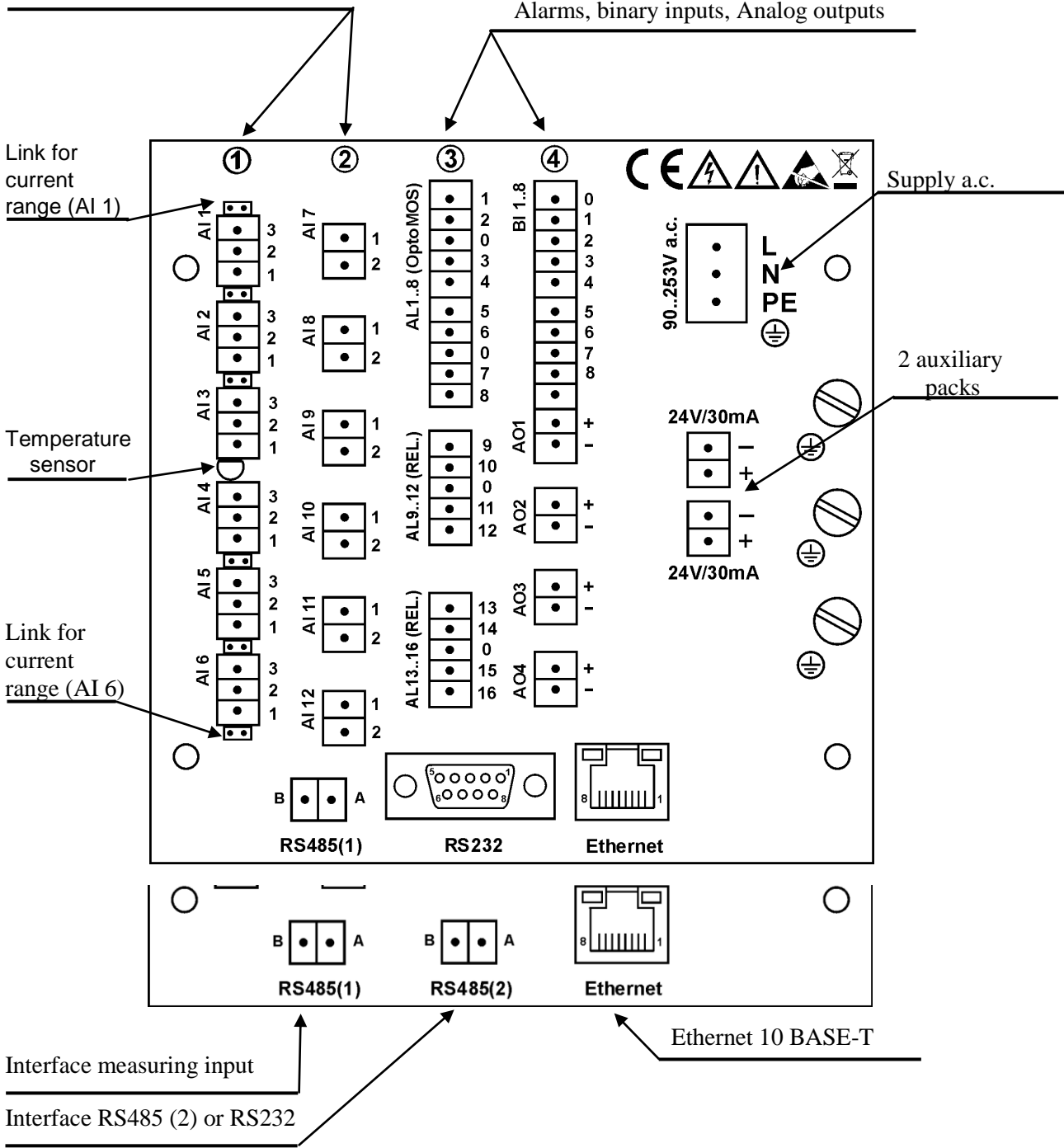
- Green colour of the diode – the recorder is set working, normal operating conditions
- Red colour of the diode – signals the storage of data on CompactFlash memory card. In these operating conditions, one must not take out the card from the seat **risk of loss of measuring data!**





### 4.3 Terminal plate

Programmable, universal and/or standard measuring channels

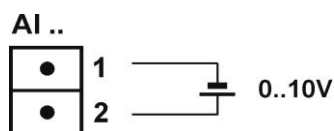
Alarms, binary inputs, Analog outputs



Symbol of terminal group	Terminal description
<b>1 and 2</b>	Connecting sockets of measuring packages ( <b>AI 1..12</b> ) - 6 or 12 standard measuring inputs - 3, 6 or 12 measuring programmable inputs.
<b>3 and 4</b>	Connecting sockets for alarm packages ( <b>AL 1..32</b> ) (8 or 16 electromechanical relays <b>REL</b> and 8 or 16 semiconductor <b>OptoMos</b> relays) <b>and/or</b> for packages of binary inputs ( <b>BI1..16</b> ) and analog outputs ( <b>AO1..8</b> ) (4 or 8 analog outputs at ranges according to the order)
<b>RS485(1)</b>	Modbus Master interface measuring input ( <b>CI 1..24</b> )
<b>RS485(2) / RS232</b>	RS-485 or RS-232 communication interface.
<b>Ethernet</b>	Connecting socket for Ethernet 10 Base-T
<b>L, N, PE</b> 	Connecting sockets for supply voltage: 90... <u>230</u> ...253 V a.c.
<b>24Vd.c. / 30mA</b>	2 object power suppliers to control external devices.
	Functional earth terminals ( to connect screens from signaling wires)

### 4.3.1 Connection of analog signals

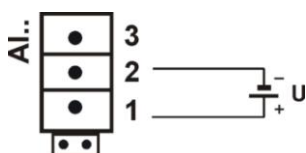
#### 4.3.1.1 Standard measuring inputs AI 1..12



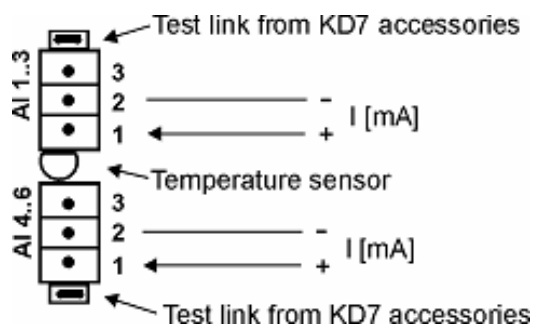
Kinds of ranges and input signals, their parameters are given in section 10 "Technical data".

#### 4.3.1.2 Programmable measuring inputs AI 1..12

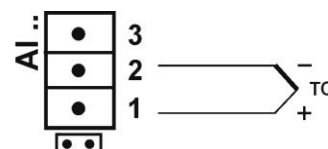
Connection of voltage source



Connection of current source

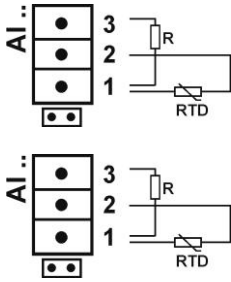


Connection of thermocouple TC

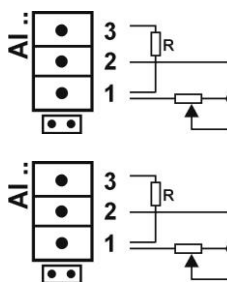


## Two-wire connection:

### - Resistance thermometer RTD



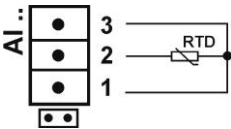
### - Resistance transmitter



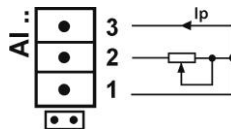
**Note:** the balancing resistance  $R$  should have a resistance equal to the total resistance of both connecting wires of RTD and transmitter with terminals

## Three-wire connection:

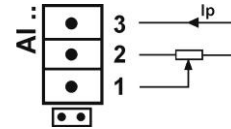
### - Resistance thermometer RTD



### - Resistance transmitter



### - Potentiometric transmitter

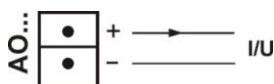


**Note:** wires connecting RTD with terminals 2 and 3 should have the same resistance

**Table 1, Thermocouples : Colour codes**

Type of thermocouple	Material	British standard BS	USA standard ASTM	German standard DIN	French standard NFE	International standard IEC 584-3
<b>T</b>	Cu-CuNi	+ white - blue * blue	+ blue - red * blue	+ red - brown * brown	+ yellow - blue * blue	+ brown - white * blue
<b>J</b>	Fe-CuNi	+ yellow - blue * black	+ white - red * black	+ red - blue * blue	+ yellow - grey * grey	+ black - white * blue
<b>K</b>	NiCr-NiAl	+ brown - blue * red	+ yellow - red * yellow	+ red - green * green	+ yellow - purplish red * yellow	+ green - white * blue
<b>R</b> <b>S</b>	Pt-Rh13Pt Pt-Ph10Pt	+ white - blue * green	+ black - red * green	+ red - white * white	+ yellow - green * green	+ orange - white * blue
<b>B</b>	Pt-Ph30Pt	Use copper wires	+ grey - red * grey	+ red - grey * grey	Use copper wires	
<b>N</b>	NiCrSi- NiSiMg	+ orange - blue * orange	+ orange. - red * brown	+ orange - red * brown	+ orange - red * brown	+ pink - white * blue
<b>E</b>	NiCr-CuNi	+ brown - blue * brown	+ brown - red * brown	+ red - grey * grey	+ yellow - purple * purple	+ brown - white * blue

### 4.3.1.3 Analog output systems AO 1..8



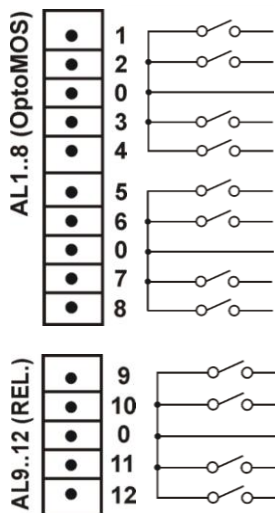
Parameters of analog output signals **AO 1..8** are given in the section 10 "Technical data"

### 4.3.2 Connection of digital signals

#### 4.3.2.1 Alarm systems AL 1..32 and binary inputs BI 1..16

##### - Connection to terminals of the alarm system with semiconductor relays:

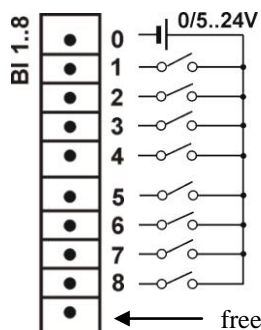
**AL1..16 (OptoMOS)** and to terminals of the alarm system with electromechanical relays **AL1..16 (REL.)**



Input parameters for the alarm system with electromechanical (**REL.**) and semiconductor relays (**OptoMOS**) are given in the section 10 “Technical data”.

Alarms with electromechanical relays (**REL.**) can be ordered with normally closed contacts (**NC**) or normally open contacts (**NO**), (see section 11: Order codes).

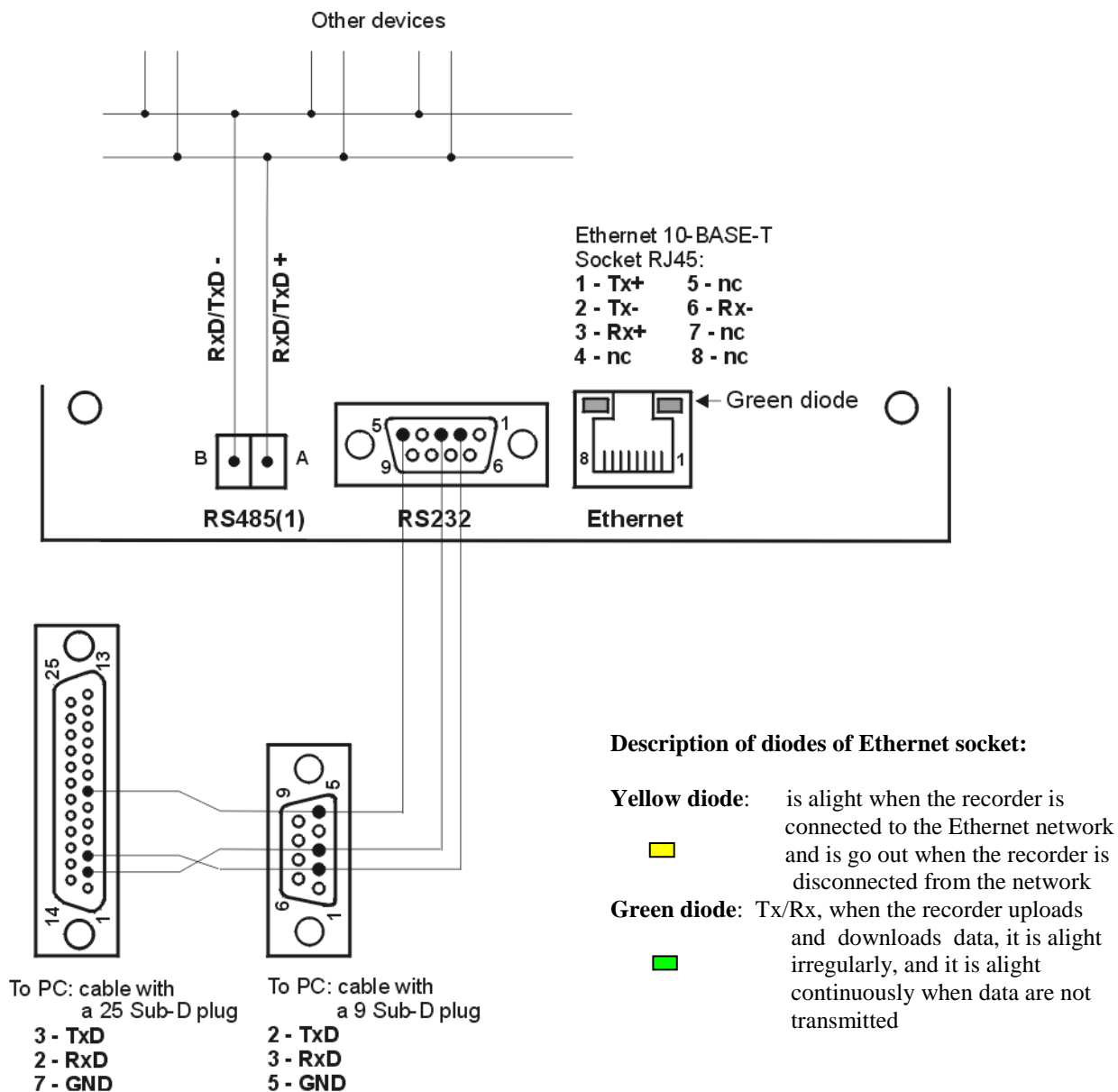
##### - Connection of the control signal to terminals of the binary input system BI 1..16



Binary inputs **BI1..16** are controlled by a signal:

- 0 V d.c. – inactive binary input or
- + 5... 24 V d.c. – active binary input.

### 4.3.2.2 Interfaces RS485(1), RS485(2), RS232, Ethernet 10-BASE-T



### Description of the Ethernet 10-Base-T interface connection

Functions of the RJ45 socket leads are in compliance with the EIA/TIA 568A/B (AT&T258) standard.

To connect the recorder with the hub (concentrator) or the switch, one must use a cable with leads 1:1 acc. to the description as on the drawing above.

To a direct KD7 recorder connection with the PC, one must use a crossover cable:

KD7		PC	
Tx +	1	3	Rx +
Tx -	2	6	Rx -
Rx +	3	1	Tx +
Rx -	6	2	Tx -

The cable length should not exceed 100 m



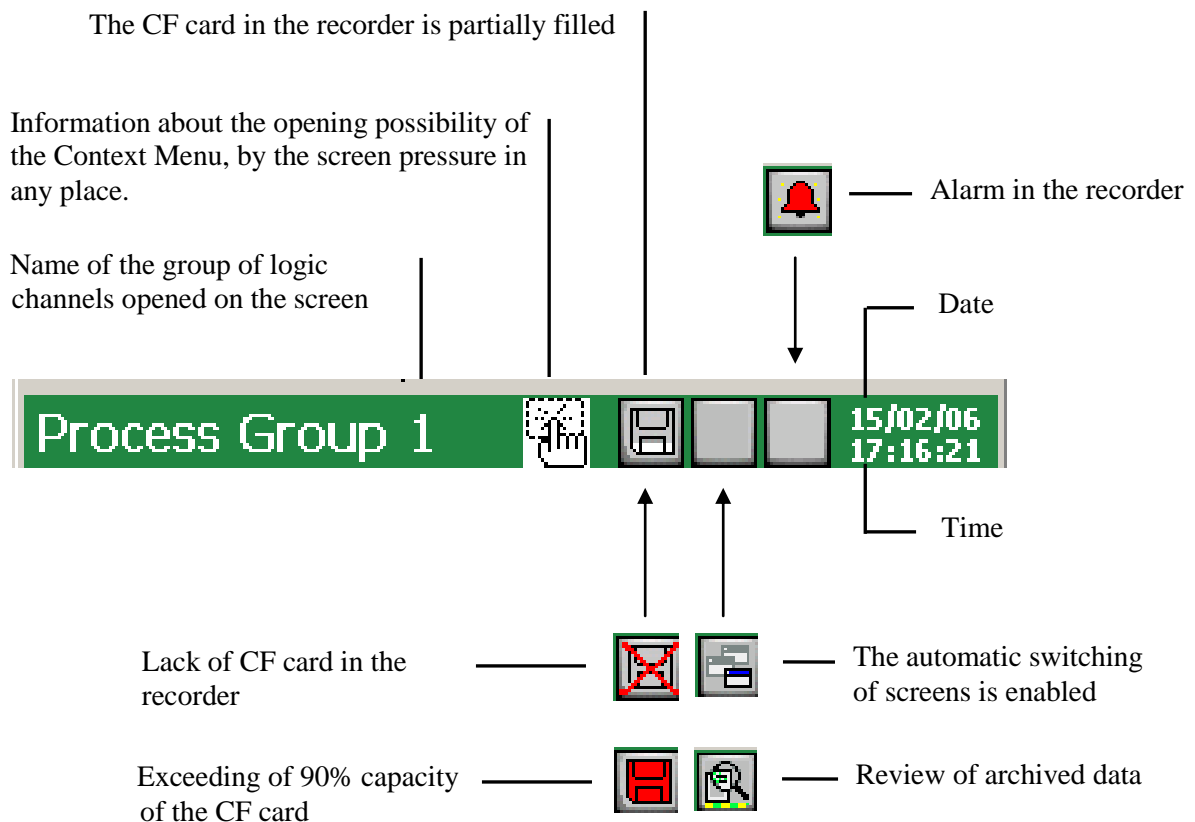
### 4.3.3 Recorder supply



**Caution: The recorder must be earthed or zeroed.**

## 5. GRAPHICAL SIGNS ON THE RECORDER SCREEN





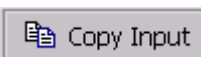




### 5.1 Status bar







### 5.2. Measuring views

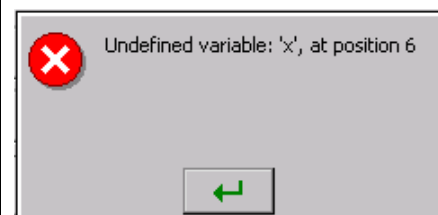
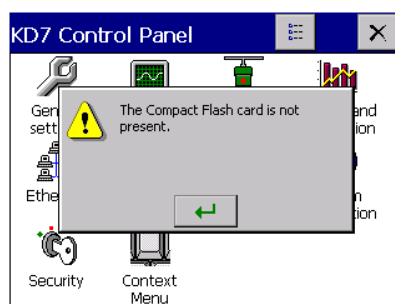
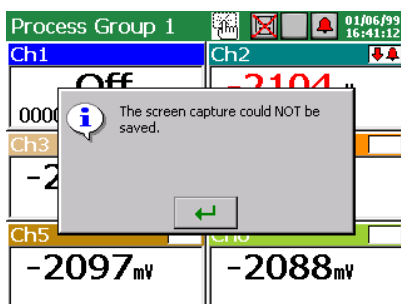
	Range overflow in the channel over the upper limit, alarm state in the channel.
	Range overflow in the channel under the lower limit
	Signaling of the alarm occurrence in the recorder.

### 5.3. Service menu

	Selection approval, introduction of changes.
	Cancellation without introduction of changes
	Buttons for global navigation
	Buttons for navigation on accessible options
	Buttons for global copying of settings between menu windows
	
	Introduction of a number or a character string.
	Option selection from the list or the dialogue
	Context help

### 5.4. Information messages

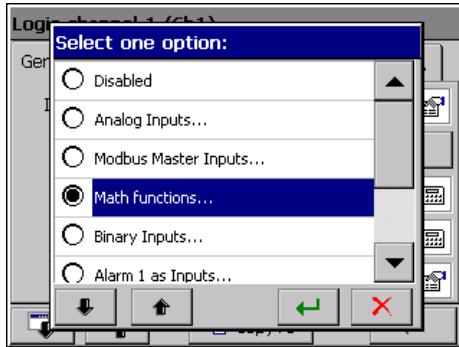
	Warning
	Symbol of error occurrence
	Request
	Information icon



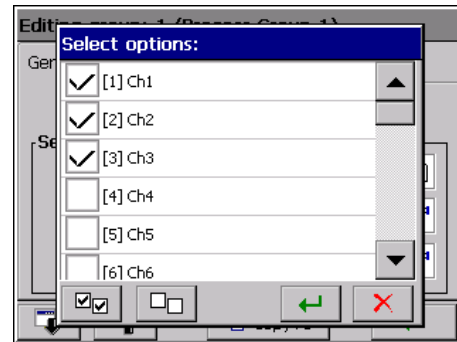
## 5.5.Dialogues

### - Selection:

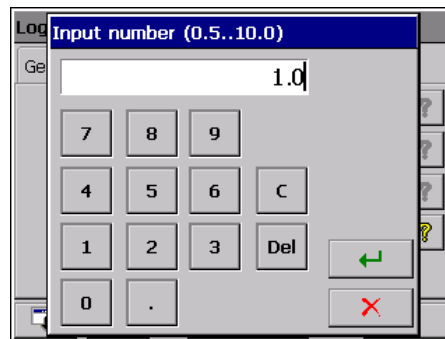
*Single:*



*Multiple:*



### - Introduction of numbers

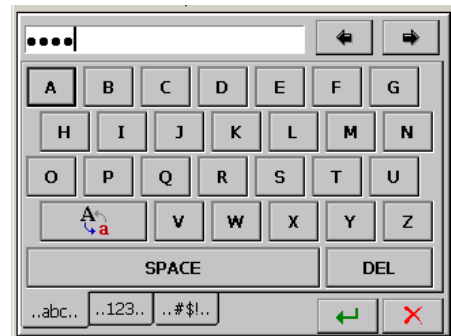
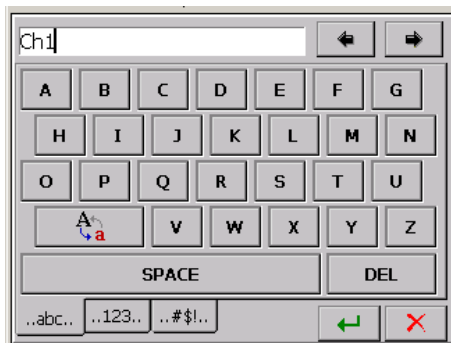


### - Introduction of a character string (small and capital letters, numbers and special characters, password)

*Small and capital letters*

*Numbers and special characters:*

*Password (replaced by dots) :*



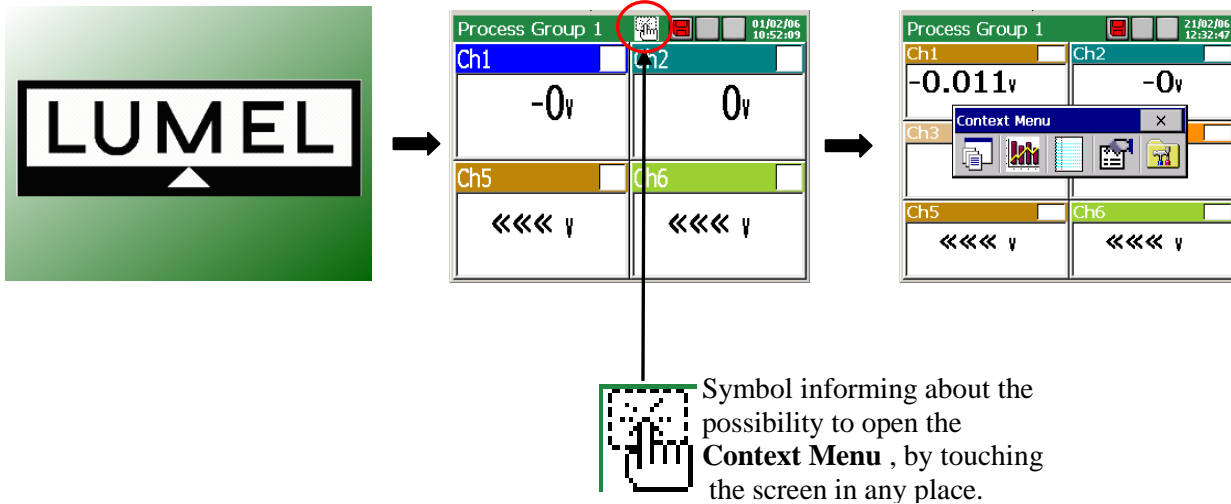
## 6. STARTING THE RECORDER

After connecting the supply, the start screen with the producer's logo.

The logo is displayed during the time necessary for the initialization of recorder processes.

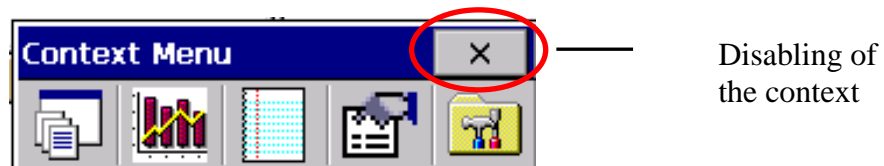
Next, the screen of data visualization appears, which was displayed at the last recorder disconnection from the network.

After the touch of the screen in any optional place, the **Context Menu** appears.

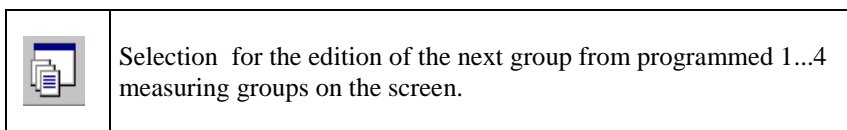


## 6.1 Context Menu

After **pressing the screen by a finger** (during the visualization of the measuring data) the **Context Menu** is displayed.

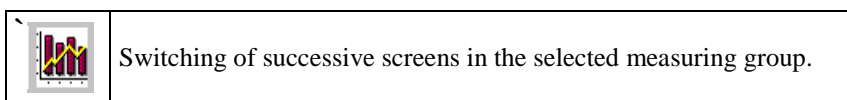


In the standard option, the basic set of functions necessary for the current service of the KD7 recorder is accessible in the menu.



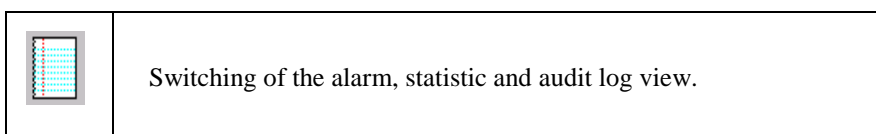
One can edit up to 4 measuring groups in the recorder.

In each group, one can program up to 6 logic channels, from 32 channels accessible in the recorder. Programming of group parameters (see section 8.2.).



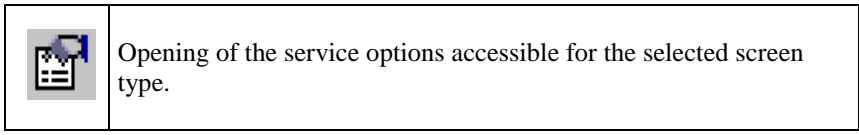
Channels programmed in the given group can be displayed on 1...5 screen types: **digital, linear, bargraph, analog, and statistic.**

Description and programming of visualization parameters (see section 8.2.).



Information concerning events occurring during the recorder work are stored in logs (see section 7.11)

**Caution:** After exceeding the log capacity, the oldest events are overwritten.



Following options are accessible for screens: digital, bargraphs, analog, and statistic.

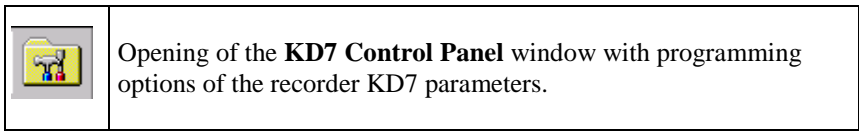
- turn on/off the switching of screens (automatic switching), see section 8.2.7,
- recording of archive data on CF, see section.8.1.6,
- removal of the CF card, see section 8.1.6,
- statistics and adders , choice of the option to control adders, see sections 8.5.3 and 8.5.4.
- confirmation of alarms, see section 8.5.2
- operator’s messages, see chapter 7.12

Following options are accessible for the linear screen:

- time scale (for the screen),
- visualized signals,
- zoom signals, see section 8.2.8,
- transition to the archive mode, see section 8.8,
- turning on/off the switching of screen, see section 8.2.7,
- storage of archive data on CF, see section 8.1.6,
- removal of the CF card, see section 8.1.6.
- confirmation of alarms, see section 8.5.2
- operator’s messages, see chapter 7.12

For each of logs (alarm, statistic and audit) following options are accessible:

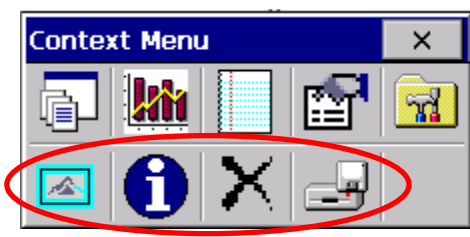
- reset this log / Reset all logs / Filter by groups..., see section 7.11,
- statistics and totalizers..., see section 8.5.4.
- confirmation of alarms, see section 8.5.2



- transition to the configuration of recorder parameters in the “**KD7 Control Panel**” window, see section 6.2.

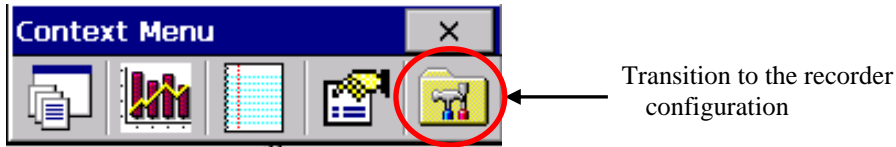
The contents of the **Context Menu** can be extended (see p. 7.9) by extra options:

- transition into the archive mode (concerns the time and linear diagram, 2D),
- screen image shot on the CF card (in the format: \*.bmp) ,
- access to system information about the KD7 recorder,
- big closing button of the **Context Menu** window.
- access to the browser of files stored on the CF card
- a direct access to options: operator’s messages and alarm acknowledgments.



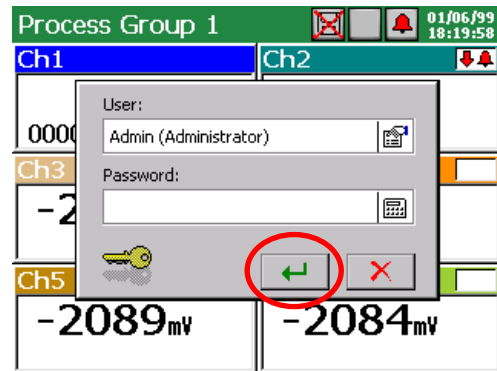
## 6.2. Entry into the recorder parameter configuration, “KD7 Control Panel” window

In order to transit into the recorder configuration, one must select the **KD7 Control Panel** symbol in the **Context Menu**:

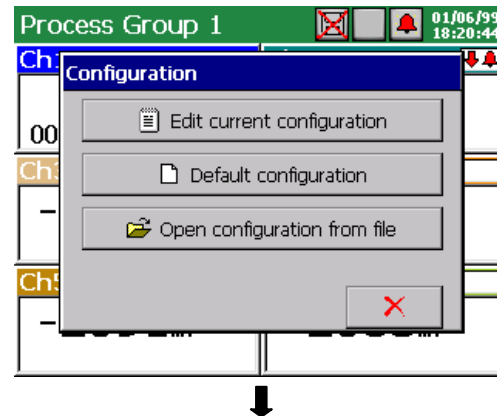


The window of the user’s selection appears, which will carry out the given configuration.

At first start, there is only the **Administrator** user. The logging follows without the password, after approving the window. The **Administrator** after transition into the **KD7 Control Panel** can edit remaining recorder’s users and change all settings concerning them, (see section p. 8.7).

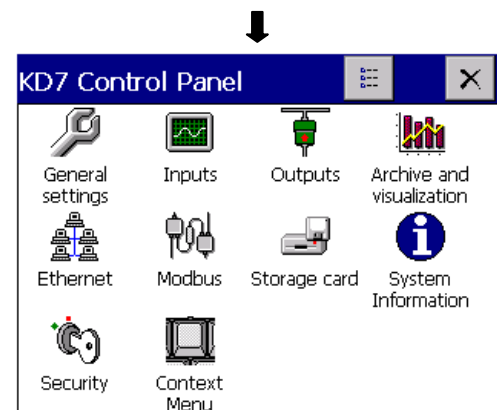


Next, one must choose the kind of the recorder parameter configuration in the **Configuration** window.

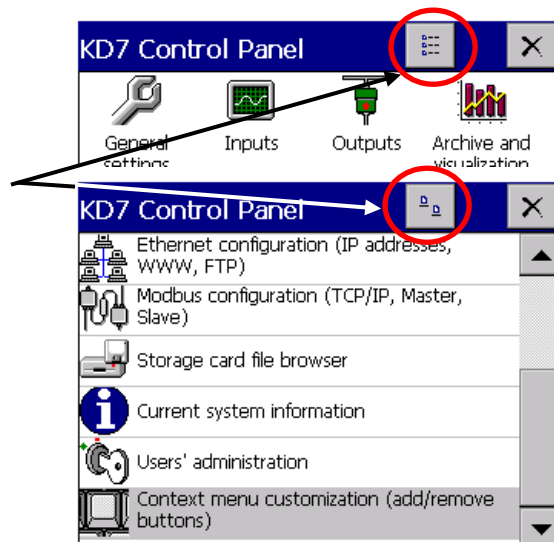


- Default Configuration** – They are factory settings or given requirements concerning individual recorder settings.
- Edit current configuration** – At first start, it is the default configuration, at next starts, the changed configuration by the user in the KD7 Control Panel (see section 7).
- Open the configuration from file** – selection of the configuration file from the recorded on the CompactFlash card.

The **KD7 Control Panel** appears. It is the initial point for carrying out the full configuration of the KD7 recorder.



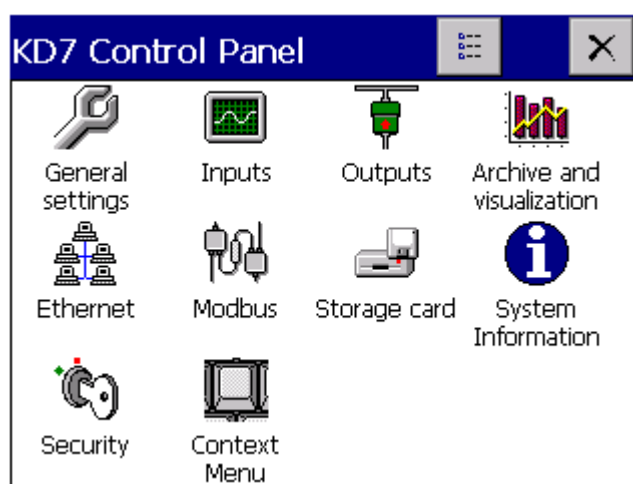
Pressing the button of the panel view change, one can switch the **KD7 Control Panel** into the description panel.  
 A renewed pressure of the button causes the return to the classical view.



## 7. CONFIGURING THE RECORDER

The **KD7 Control Panel** is the window in which we obtain the direct access to the KD7 servicing menu:


- general settings of the recorder, see section 7.1
- configuration of logic channels, see section 7.10
- configuration of outputs (alarms, analog outputs), see section 7.6
- setting of visualization and archiving parameters, see section 7.8
- configuration of event logs, see section 7.11
- configuration of alarms in the measuring channel, see section 8.5.2
- setting of communication interface parameters, see section 7.2, 7.3
- service of the CF card, review of files, see section 8.1.5
- read out of information about the recorder, see section 7.5
- setting of access principles to recorder configuration changes , see section 7.4
- configuration of the context menu, see section 7.9



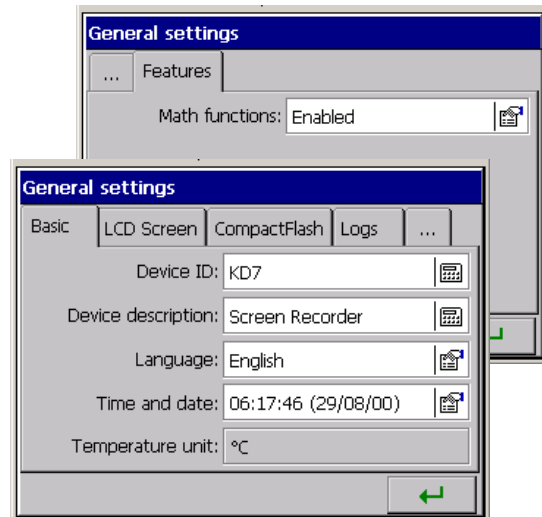
- Note:**
1. In descriptions of the KD7 Control Panel menu, exemplary data are written in inclined printing.
  2. During the recorder configuration, the measurement and data storage last according to hitherto existing settings. When we transit to new settings, after accepting changes, a break in storage, initialization of changes and starting of recording with new data follows.  
 Only in case of the date change, the change is immediately introduced and the storage lasts acc. to the new setting.

## 7.1 General settings










After pressing the  icon, the configuration of general parameters is coming open: recorder description, selection of the menu language, setting of the date and time, selection of the temperature unit, capacity of the event log (audits), time of screen blanking, setting of screen brightness.


The procedure of the touch screen calibration is also accessible (see section 8.9).



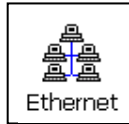
Programming menu of general settings:

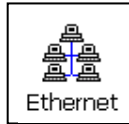
<b>Basic</b>	<b>Device ID:</b>	<i>KD7</i>	 <b>Description edition</b>
	<b>Device description:</b>	<i>Screen Recorder</i>	 Description edition
	<b>Language:</b>	<i>English</i>	 <b>Selection:</b> - Polish, Russian - English, Italian - French, Romanian, - Portuguese (Brazil)
	<b>Time and date:</b>	<i>12:00:00 (24/01/06)</i>	 <b>Settings:</b> - Data and Time - Time zone - Time server
	<b>Temperature unit:</b>	<i>°C</i>	
<b>LCD screen</b>	<b>Screen saver:</b>	<i>15 min.</i>	 <b>Selection:</b> - Disabled - 5,10,15,30 min. - 1,6,12 hours
	<b>LCD backlight:</b>	<i>100%</i>	Setting of the screen brightness
	<b>Touch screen calibration:</b>		See section 8.9.
<b>CompactFlash</b>	<b>Selection: fast formatting of CF card/full formatting of CF card</b>		
<b>Logs</b>	<b>Audit log size:</b>	<i>50</i>	 <b>Edition of the parameter value</b>
	<b>Audit log size:</b>	<i>50</i>	
	<b>Audit log size:</b>	<i>50</i>	
<b>Other</b>	<b>Operator messages:</b>	<i>MSG1...</i>	 <b>Choice:</b> - <b>Choice and edition of messages</b> MSG1..10

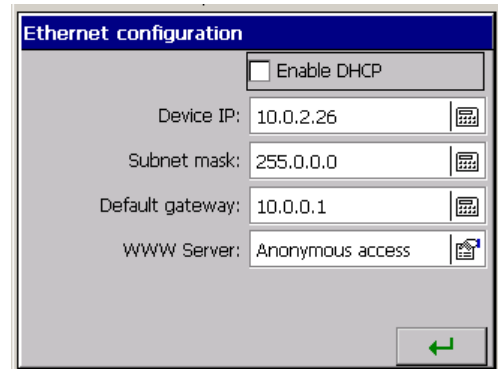


	<b>Math functions:</b>	<i>Disabled</i>	 <b>Selection :</b> - Disabled - Activate - (activation procedure see section 7.10.3.3)
--	------------------------	-----------------	---






## 7.2 Ethernet



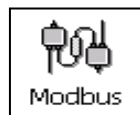
After pressing the  icon, the window of parameter configuration of the Ethernet interface is coming open.

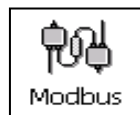


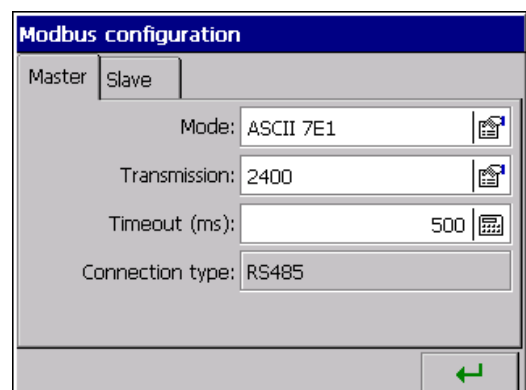
### Programming menu of Ethernet interface parameters .

Enable DHCP	<input type="checkbox"/>	<input checked="" type="checkbox"/>	Mark the selected function
<b>Device IP</b>	<i>10.0.2.26</i>	<i>10.0.2.26</i>	 <b>Address edition</b>
<b>Subnet mask:</b>	<i>255.0.0.0</i>	<i>255.0.0.0</i>	 <b>Address edition</b>
<b>Default gateway:</b>	<i>10.0.0.1</i>	<i>10.0.0.1</i>	 <b>Address edition</b>
<b>WWW Serwer</b>	<i>Anonymous access</i>	<i>Anonymous access</i>	 <b>Selection:</b> Disabled Access with NTLM authorisation Users' access Anonymous access
<b>FTP Serwer</b>	<i>Anonymous access</i>	<i>Anonymous access</i>	 <b>Selection:</b> Disabled Users' access Anonymous access









## 7.3 Modbus



After pressing the  icon, the configuration window of the Modbus communication protocol is coming open. In the case of Modbus TCP Slave, parameters such as: mode, transmission, ID and response delay are ignored. Modbus TCP works on 502 port (default). The addressees of registers are identical for both Modbus Slave and Modbus TCP Slave. Modbus TCP Slave allows connection of up to 10 clients.




Programming menu of Modbus Master and Modbus Slave interface parameters:

<b>Master</b>	<b>Mode:</b>	<i>RTU 8N2</i>	 <b>Selection:</b> ASCII 8N1, ASCII 7N2, ASCII 7N1, ASCII 7O1, RTU 8N2, RTU 8E1, RTU 8O1, RTU 8N1,
	<b>Transmission:</b>	<i>28800</i>	 <b>Selection:</b> 300, 600, 1200, 2400, 4800, 9600, 14400, 19200, 28800, 38400, 56000, 57600, 115200, 128000, 256000
	<b>Timeout (ms):</b>	<i>500</i>	 <b>Edition of the parameter value</b>
	<b>Connection type:</b>	RS485	
<b>Slave</b>	<b>Mode:</b>	<i>RTU 8N2</i>	 <b>Selection:</b> ASCII 8N1, ASCII 7N2, ASCII 7N1, ASCII 7O1, RTU 8N2, RTU 8E1, RTU 8O1, RTU 8N1,
	<b>Baud rate:</b>	<i>28800</i>	 <b>Selection:</b> 300, 600, 1200, 2400, 4800, 9600, 14400, 19200, 28800, 38400, 56000, 57600, 115200, 128000, 256000
	<b>ID:</b>	<i>1</i>	 <b>Edition of the parameter value</b>
	<b>Response Delay:</b>	<i>0</i>	 <b>Edition of the parameter value</b>
	<b>TCP/IP Settings</b>	<b>TCP/IP:</b>	
<b>Port:</b>			 <b>Edition of the parameter value</b>

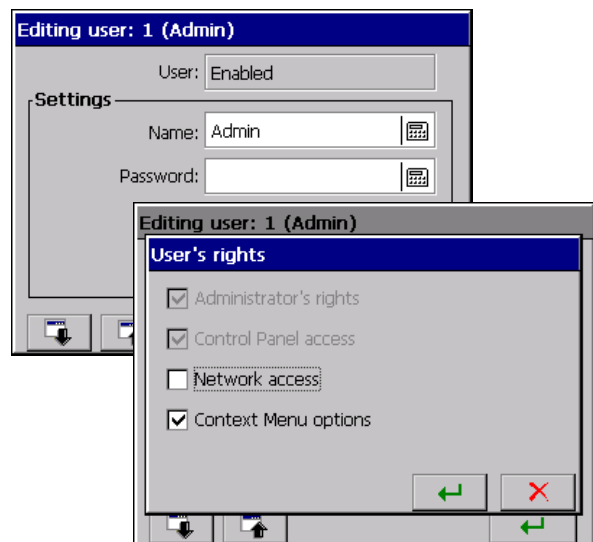
- Note:** 1. The register map is accessible in the user's manual of the Modbus communication protocol.  
2. For the Modbus Slave protocol, only actual values of measurements are accessible (32 registers).

## 7.4. Security

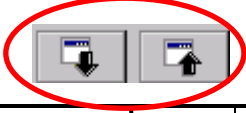






After pressing the  icon, the edition window 1...8 of recorder users and settings principles of their access to the recorder configuration (see section .8.7) is opening.

One must establish the password for each user to protect against the access and introduction of non-authorized changes in the recorder configuration.



Programming menu of access principles to KD7 configuration.

<b>Editing user:</b>		 <b>Selection: 1 (Admin), 2 (User 1)...8 (User 7)</b>	
<b>User</b>	1 (Admin)	Enabled (access to all settings)	
	2 (User 1)...8 (User 7)	<i>Enabled</i>	 <b>Selection:</b> Disabled/ Enabled
<b>Settings</b>	<b>Name:</b>	<i>User 1</i>	 <b>Name edition</b>
	<b>Password:</b>	...	 <b>Password edition</b>
	<b>Access rights:</b>	Access code	 <b>Selection:</b> Administrator's rights, Control Panel access, Network access, Context Menu Options

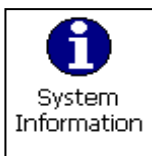
Scrolling of the users' list.

**Note:**

**Network access** – Access to the recorder in Ethernet network

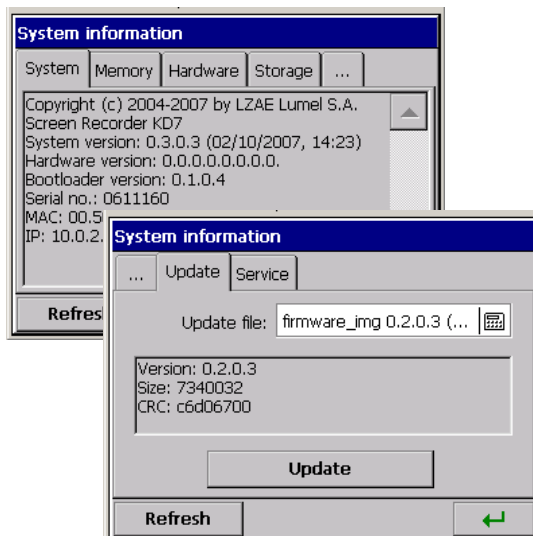
**Administrator's rights** – User 1 (Admin) can edit other users and change all their settings.

**7.5. System information**




After pressing the icon, the window with information about the recorder system is opening. It informs about the hardware installed in the recorder and the state of the CompactFlash card and level of the data buffer filling with data from the 1..4 measuring group.

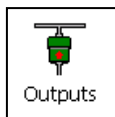
There is also the system updating service tab (see section 8.10) and the access for servicing personnel (the service of the recorder is only accessible for the manufacturer and distributors).



Systemic information and menu of system visualization:

<b>Systemic information</b>	<b>System:</b>	<b>Information about the recorder:</b> <b>Name:</b> <i>KD7 touch screen recorder</i> <b>System version:</b> <i>0.4.0.10 (09/04/2008, 09:28)</i> <b>Bootloader version:</b> <i>0.1.0.6</i> <b>Serial number:</b> <i>00000000</i> <b>MAC:</b> <i>12.13.17.28.31.1A</i> <b>IP:</b> <i>0.0.0.0 (the network is not connected)</i>	
	<b>Memory:</b>	<b>Memory fulfilling:</b> <i>48%</i> <b>Available physical:</b> <i>3.33 MB (3408 KB)</i> <b>Total physical:</b> <i>6.37 MB (6520 KB)</i>	
	<b>Hardware:</b>	<b>Slot 1:</b> <i>empty or the name of introduced card</i> <b>Slot 2:</b> <i>empty or the name of introduced card</i> <b>Slot 3:</b> <i>empty or the name of introduced card</i> <b>Slot 4:</b> <i>empty or the name of introduced card</i>	
	<b>Storage:</b>	<b>The Compact Flash card is not introduced</b> <i>or information about the introduced card</i> <b>CompactFlash card:</b> <i>introduced</i> <b>Fulfilling of the CF card:</b> <i>85%</i> <b>Free space on the CF card:</b> <i>2,31MB (2364 KB)</i> <b>Total capacity of the CF card:</b> <i>15,28 MB (15648 KB)</i> <b>State of internal buffer:</b> Information about the number of free records and KD7 worktime to fill the buffer of each active measuring groups.	
	<b>Update:</b>	<b>Update file:</b>	 <b>Selection:</b> <b>File browser</b> – selection from the stored configuration files on the CF card.
	<b>Updating:</b>	Start of the system updating procedure	
<b>Service</b>	<i>Menu accessible for authorized users</i>		

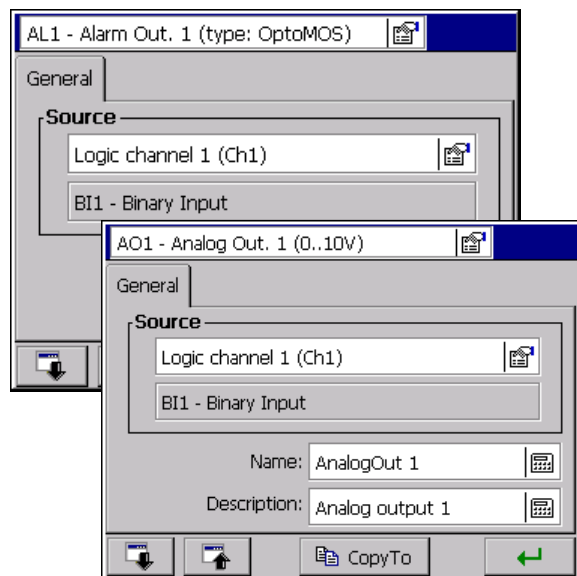
## 7.6. Alarm and analog outputs



After pressing the **Outputs** icon, the configuration window of alarm outputs or analog outputs is opening (see section 8.6). For each of them, one must select the source of the signal, write the name and description in








For the **Alarm Output**, the signal source can be one of the 32 logic channels or one of two alarms (A1, A2) of the chosen logic channel see section 8.6.2.

For the **Analog Output**, the signal source can be one of the 32 logic channels (see section 8.6.1.)




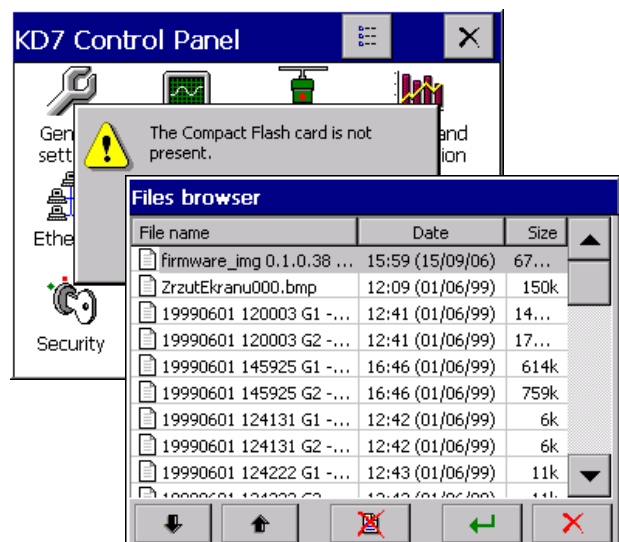
**Note:** the alarm type, activation level and hysteresis are settled when configuring the given logic channel (**Output** icon), see section 8.5.2.

Menu to program alarms and analog outputs:

		<b>Selection:</b>		
		Selection of the <b>alarm or analog output</b> from the list of accessible outputs in the recorder.		
<b>General</b>	For the selected alarm Output	<b>Source:</b>	Alarm 1 of logic channel 2 (Ch2)	 <b>Selection:</b> Disabled /Logic channel selection (1..32) / Choice of the alarm (A1 or A2) of the chosen logic channel.
			AI6 – Analog input	Information about the measuring input assigned to the selected logic channel (see section 7.10)
		<b>Name:</b>	AlarmOut 1	 <b>Name edition</b>
		<b>Description:</b>	Alarm output 1	 <b>Description edition</b>
	For the selected analog Output	<b>Source:</b>	Logic channel 1 (Ch1)	 <b>Selection:</b> Disabled/Logic channel selection (1..32)
			AI6 – Analog input	Information about the measuring input assigned to the selected logic channel (see section 7.10)
		<b>Name:</b>	AlarmOut 1	 <b>Name edition</b>
		<b>Description:</b>	Alarm output 1	 <b>Description edition</b>

### 7.7. CF card

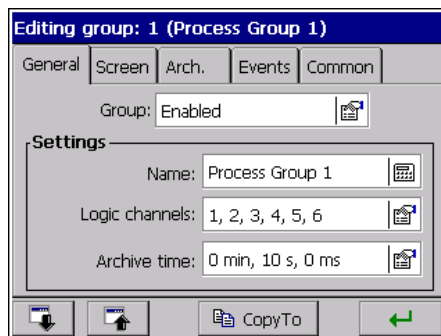
After pressing the  icon, when the CF card is set into the recorder, the file browser window is opening. When there is no card, suitable message appears.



## 7.8. Configuration, visualization and archiving of the channel group









After pressing the icon, the window of programming and visualization of 1...4 groups of channels is opening. One must define the group name, select 1..6 logic channels for the group and program visualization parameters and data archiving, (see section 8.2).



Programming menu of the selected group of channels:

Edited group:		Selection of the group:	
		1 (Process Group 1) ... 4 (Process Group 4)	
General	Group:	<i>enabled</i>	
	Settings:	Name:	<i>Process Group 4</i>
		Logic channels:	<i>1,2,19,21,22</i>
		Archive time:	<i>0 min., 10 sec., 0 ms</i>
Screen	Screens:	<i>1,2,3,4,5</i>	
	Charts orientation:	<i>horizontal</i>	
	Line width:	<i>1</i>	
	Background:	<i>Black</i>	
	<input checked="" type="checkbox"/>	Common settings for all groups (mark if common)	
Arch.	Alarms log:		Selection:  Off / On – Log archiving (storage in the file)
	Statistics log:		

<b>Events</b>	<b>Arch. disabled by:</b>		 <b>Selection:</b> Lack/Logic channel selection, the state of which influences the event realization.
	<b>Save data on CF:</b>		
	<b>Create new file:</b>		
<b>Common</b>	<b>Auto-views delay:</b>	<i>10s</i>	 <b>Edition</b> Setting of the screen switching time in the given group
	<b>Events:</b>	<i>Lack, Lack</i>	 <b>Edition of parameter value</b>
	<b>Timeout for arch-mode:</b>	<i>15min.</i>	 <b>Selection</b> Setting of the time after which the automatic exit from the archive mode follows.
	<b>File format:</b>	<i>CSV</i>	 <b>Selection:</b> CSV / CSV with digital signature/Binary with digital signature
	<b>Audit log (arch.):</b>	<i>Enabled</i>	 <b>Selection:</b> ON/OFF – Archiving of the audit log (storage in the file)

**Where:**

**Storage period** – period of data storage from the selected group into the memory.

**Switching period** – switching period of screens into the given group

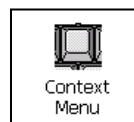
**Orientation: vertical/horizontal** – concerns the data visualization in the shape of linear charts and bargraphs.

**Storage of data on CF:** change of the chosen logic channel state (from 0 into 1) forces the storage of all data from the memory into CF.

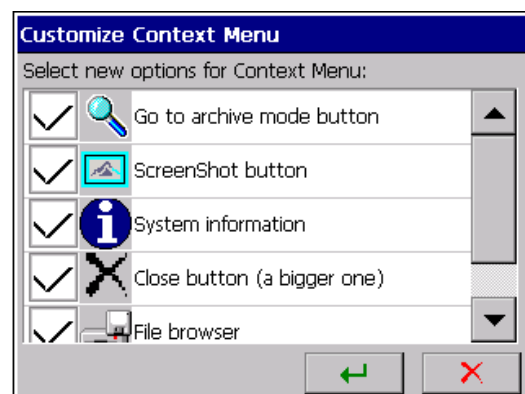
**Archive disabled through:** the chosen logic channel state (1 / ON) disables data archiving.








**Create a new file:** the change of the chosen logic channel state ( from 0 into 1) causes the creation of a new file with measuring data.

## 7.9 Context menu



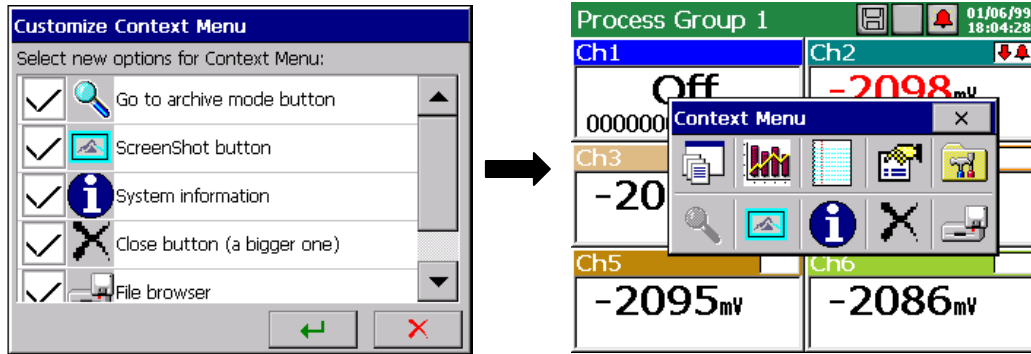
After pressing the Context Menu icon, the window of the additional option selection for the context menu is opening.



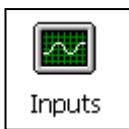
	Fast transition into the archive mode (accessible only during the linear screen display).
	Storage of the image of the presently displayed screen on the CF card ( in *.bmp format) .
	Access to the <b>system information</b> window.
	Big button to close the <b>Menu context</b> window
	Opening the <b>Files Browser</b> window to review files stored in the CF card
	Operator's messages
	Alarm confirmation

In the **Customize context Menu** window, one can mark selected functions for the context menu.

The extended version of the context menu will be accessible after confirming the selection, exiting from the KD7 Control Panel, storage and setting the changed recorder configuration.

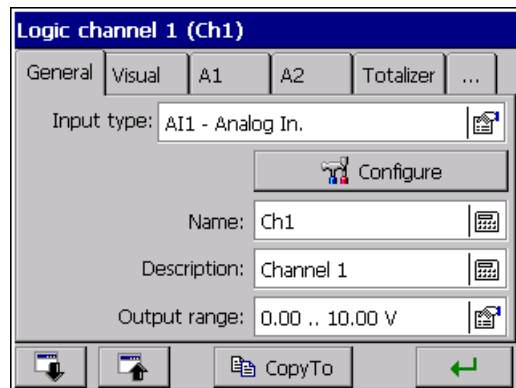


### 7.10 Inputs (logic channels)



After pressing the **Inputs** icon, the programming window 1...32 logic channels is opening.

For each selected logic channel, one can:  
 select and configure the input type,  
 describe the channel, set the output range,  
 the chart color, zoom of signals,  
 parameters of alarms A1 i A2, totalizer parameters (integral or counter) and parameters that will be common for all logic channels.





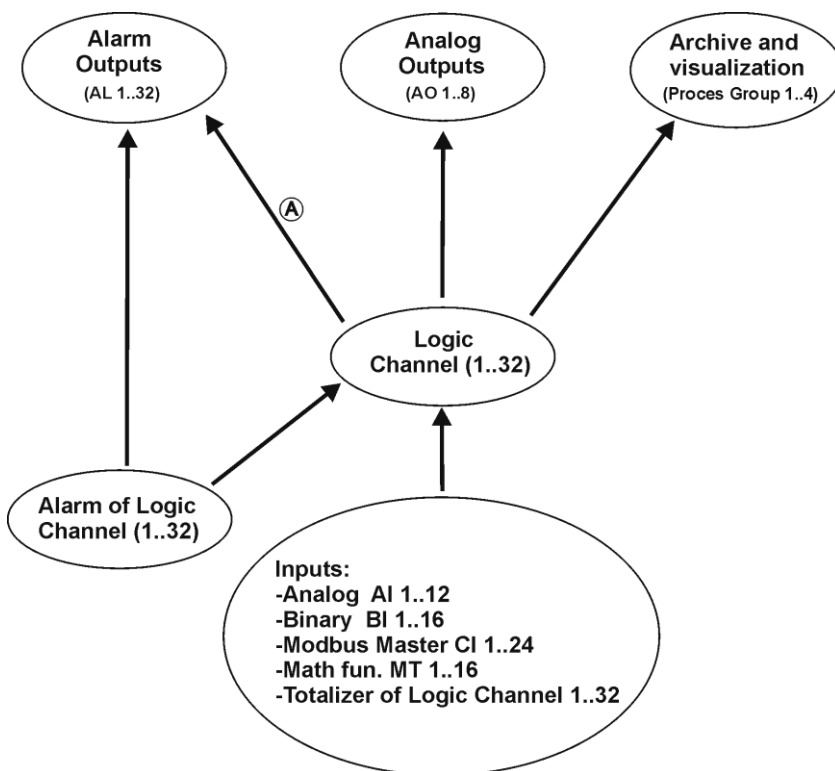
### 7.10.1 Definition of the logic channel

Logic channels are medium elements between inputs (see section 7.10) and outputs (see section 7.6 ) allowing to a flexible creation of connections between them.

Analog inputs (**AI 1..12**), interface inputs (**CI 1..24**), mathematical functions (**MT 1..16**), binary inputs (**BI 1..16**), logic channel alarms (**A1,A2**) and logic channel totalizers (**1..32**) are inputs for logic channels.

The **Logic Channel (1..32)** is the signal source for alarm outputs (**AL 1..16**) and analog outputs (**AO 1..8**). For alarm outputs (**AL 1..16**) the signal source is also one of alarms (**A1, A2**) of the chosen logic channel.

Measuring data from logic channels are archived and visualized in the recorder, in four groups (**Process Group 1..4**) with 6 logic channels in each group.

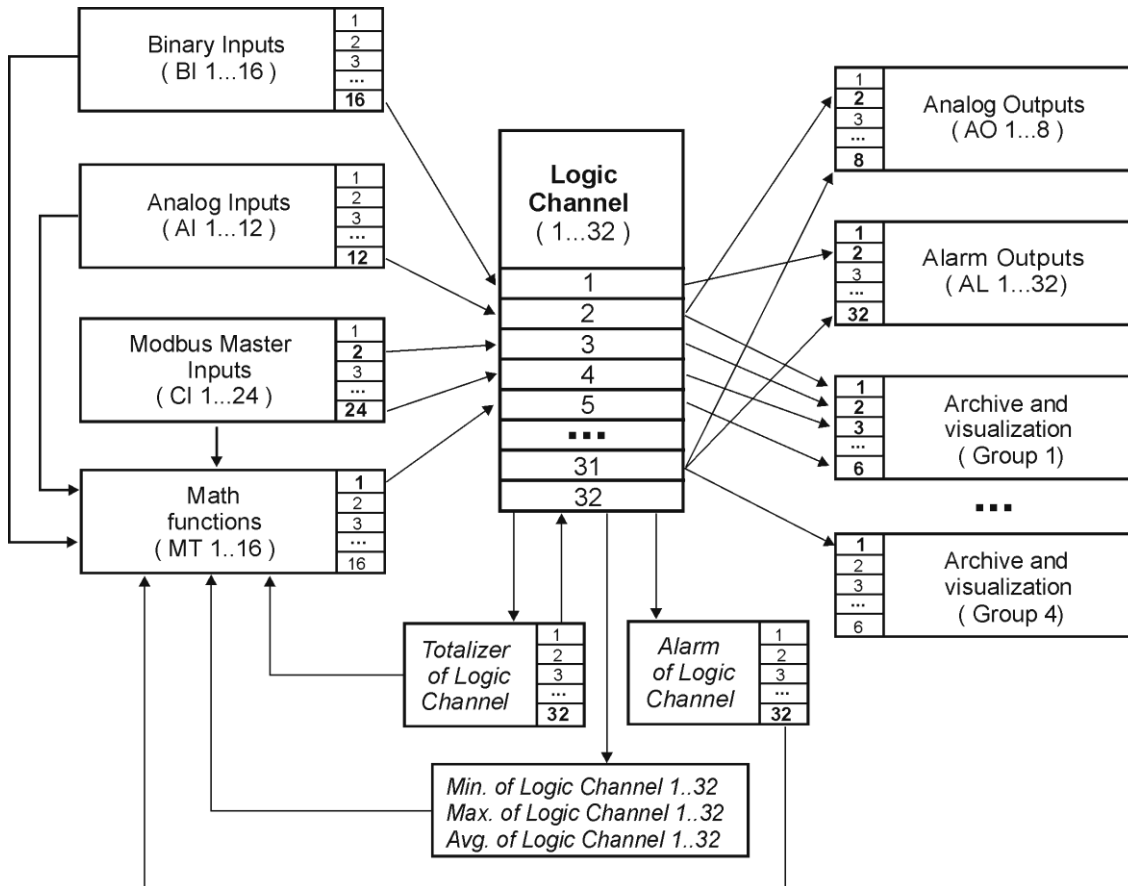


**Note A:**

When the analog signal from the logic channel (1..32) is assigned to the alarm output (AL 1..16), then the value of the analog signal is interchanged into a binary value controlling the alarm output acc. to the principle:

- when the analog value **is higher** than “**O**”, then it is treated as a logic value “**1**”.
- when the analog value **is smaller** than “**O**”, then is is treated as a logic value “**O**”.

















Exemplary presentation of connections between logic channels, inputs and outputs:












Possibilities resulting from the application of the intermediating element in the form of logic channels:

- In successive logic channels, one can group inputs related with a defined process (independently on the kind of these inputs), what facilitates the configuration of outputs.
- During the output configuration, the knowledge of input configuration is not required but only the connection of individual logic channels with elements monitored process by the recorder.
- The change of the input configuration ( e.g. from the measurement through the recorder analog input into the measurement obtained from another device through the communication interface) at the unchanged process does not involve the necessity to renew the configuration of outputs.

## 7.10.2 Menu of logic channel programming

Logic channel		  Selection : <b>Ch1 ... Ch32</b> / Copy to: copying of settings into the selected channel		
General	Input type:	All-Analog input ,0-10V	 <b>Selection:</b> Disabled / Analog inputs, Modbus Master inputs, Mathem. functions, Binary inputs, Alarms as inputs.	
		 Configure Menu of the selected input Configuration: Analog, Modbus Master, mathematical functions, Binary 1..16, logic channel alarm 1..32		
	Name:	Ch2	 <b>Name edition</b>	
	Description:	Channel 32	 <b>Name edition</b>	
	Output range:	-9999..9999mV	 <b>Edition of parameters:</b> Precision, Min, Max, Unit <i>or</i> Copy from the input.	
Visual	Color:	C=255, Z=140, N=0	 <b>Selection of the diagram line colour on the screen</b>	
	Zoom scale :	0.0 – 100.0 mV	 <b>Edition of parameters</b> Min, Max <i>or</i> Copy from the input	
Alarm: A1 / A2	Alarm type:	Min	 <b>Selection:</b> Disabled, Min, Max, Range On, Range Off, On Error	
	Alarm value:	2.00	 <b>Edition of the parameter value</b>	
	Alarm hyst.:	Value; 0.00; 0 sec.	Type:	Percentage, Value, Percentage Off, Value Off
			Percentage:	 <b>Edition of the parameter value</b>
			Hyst. value:	 <b>Edition of the parameter value</b>
			Time:	 <b>Edition of the parameter value</b>
	Alarm controls:	Accept; None	Confirm type:	 <b>Selection:</b> None, Latch, Accept
			Alarm disabled by:	 <b>Selection:</b> None, Logic channels [1..32]
Input control:			<b>Selection:</b> Enabled/Disabled	

	<b>Alarm log:</b>	<i>enabled</i>	 <b>Selection:</b> On/Off – storage of the alarm in the log file
--	-------------------	----------------	--

<b>Totalizer</b>	<b>Type:</b>	<i>Integral</i>	 <b>Selection:</b> Disabled, Integral, Counter
	<b>Units and events</b>	<i>V, Lack, Lack</i>	 <b>Selection and edition:</b> Unit, Totalizer disabled through, Totalizer reset through
	<b>Numeric settings</b>	<i>0, Integral 0.000000, 1.000000, 0, 1000</i>	 <b>Selection and edition:</b> Decimal point, counting direction, Boundary value, Multiplier, Negative ranges,, Min and max values
	<b>Time settings:</b>	<i>1 minut, Continuous</i>	 <b>Selection and edition:</b> Time base, Counting type, Daily reset at hour
	<b>Alarm settings:</b>	<i>Disabled</i>	 <b>Totalizer alarm:</b> Disab/Enab. – Setting of alarm value
<b>Common</b>	<b>Alarms disabled by:</b>	<i>Lack</i>	 <b>Selection:</b> Lack, Logic channels (selection from 1..32 channels)
	<b>Totalizers disabled by:</b>	<i>Lack</i>	 <b>Selection:</b> Lack, Logic channels (selection from 1..32 channels)
	<b>Totalizers reset by:</b>	<i>Logic Chanel 1</i>	 <b>Selection:</b> Lack, Logic channels (selection from 1..32 channels)

**Totalizer reset:** - The activation follows when the logic state of the selected source changes from 0 into 1

**Output range:** - During measurement of the input quantity, the proportional output value in limits defined by this parameter is displayed on the screen.

**Zoom of signals:** - During the display of the analog screen (linear chart), after opening the context menu and selecting the option: **Zoom of signals** in it, the selected channel is displayed on the analog screen, in limits defined by this parameter (see p. 8.2.8.)

Parameters common for all channels ( can be globally modified through the change of each of them in any channel ):

**Alarms disabled by:** - The activation follows if the selected source will be in the logic state 1.

**Totalizers disabled by:** - The activation follows if the selected source will be in the logic state 1

**Totalizers reset by:** - The activation follows when the logic state of the selected source changes from 0 into 1

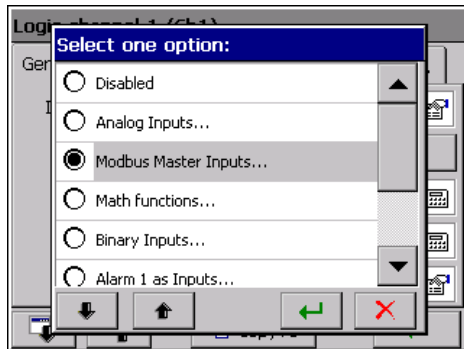
When controlling alarms and totalizers, the output value of the logic channel higher than zero is interpreted as the logic state 1 (ON).
--



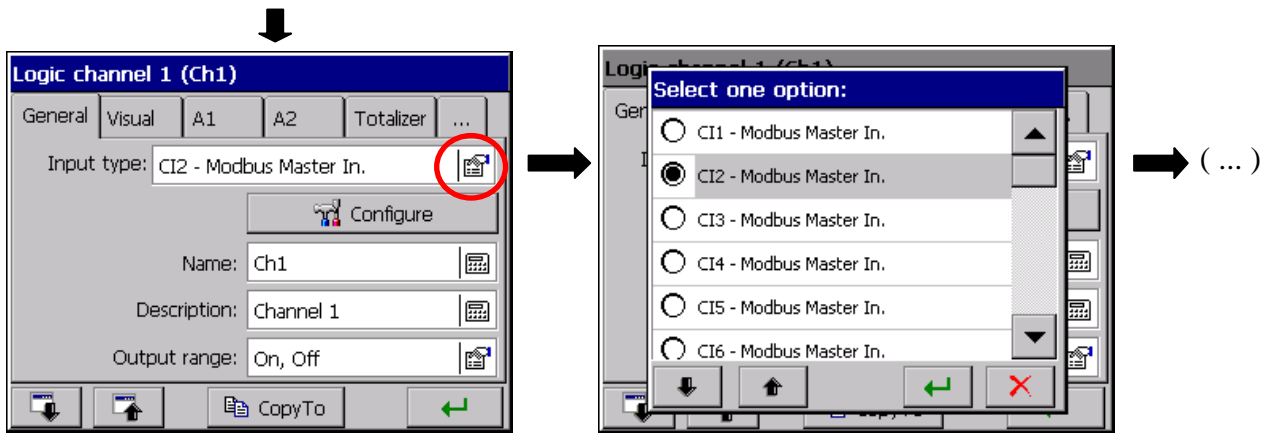
### 7.10.3 Selection and configuration of an input for a logic channel.



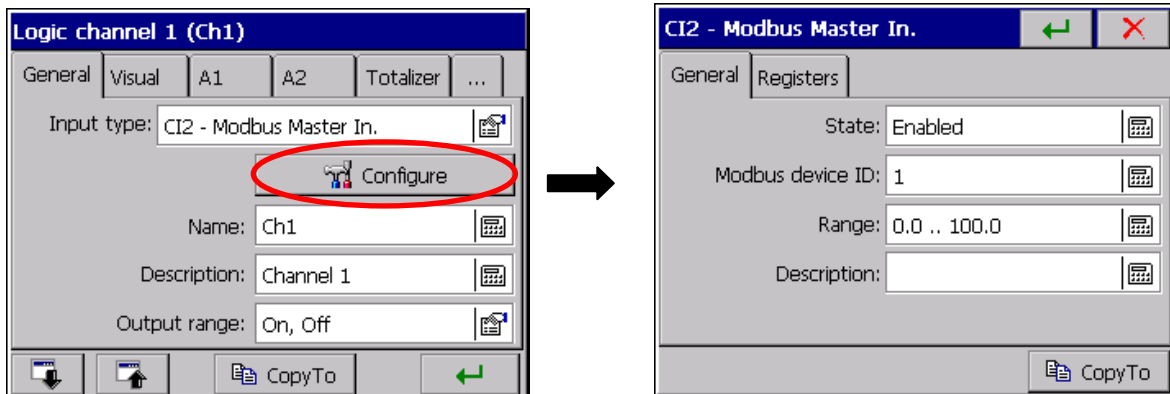
In the selection menu and configuration of inputs, for the set logic channel, options to disable this channel are accessible or the selection and configuration of one of the accessible input.










- Analog measuring input,
- Interface measuring input
- Mathematic function,
- Binary input,
- Logic channel alarm (A1 or A2)
- Logic channel totalizer



#### 7.10.3.1 Modbus Master Input CI 1..24

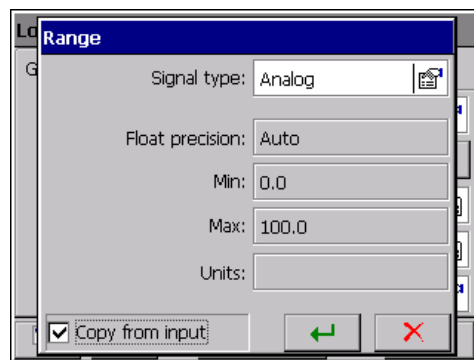
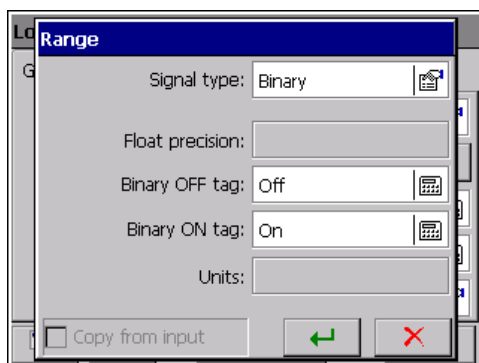


## Programming menu of interface inputs (Modbus Master):

Configuration CI1 - Modbus Master inputs			
General	State:	<i>enabled</i>	 Selection: Disabled/ enabled
	Modbus device ID:	<i>1</i>	 Parameter edition
	Range:	<i>0.0 – 100.0</i>	 Edition of parameter values: Min and Max of the range
	Description:		 Description edition
Registers	Register address:	<i>0</i>	 Parameter edition
	Register type:	<i>int</i>	 Selection: char, int, long, float, float (bytes:1234), float (bytes:2143), float (bytes:4321), float (bytes:3412)
	Read function	<i>Function 3</i>	 Selection : Function 3, Function 4

**Note:** set Modbus Master input parameters acc. to the specification of the connected device.

For the logic channel with the input of Modbus Master type write the name and channel description, and set parameters of the output range (Signal type: Analog / Binary, Float precision, Min, Max and Units). One can also select the parameter copying: Precision, Min, Max, and Unit from the measuring input to the output.



**Selection of the analog signal type** means that the signal from this input will be treated as continuous and in this form, the logic channel will be visualized and archived.

**Selection of the binary signal type** means that the signal of this input will be converted into two output states 0 or 1 and in this form, the logic channel will be visualized and archived.

### 7.10.3.2 Analog input AI 1..16

#### a. Standard analog inputs AI 1 ... AI16:

<b>Configuration AI1 – Analog inputs 0...20mA</b>			
<b>General</b>	<b>Range:</b>	0.00 ... 20.mA	<b>Selection:</b> Opening the menu of range programming

<b>Range</b>	<b>Precision:</b>	Auto		
	<b>Min:</b>	5.00		<b>Edition of the parameter value</b>
	<b>Max:</b>	10.00		<b>Edition of the parameter value</b>
	<b>Units:</b>	mA		

**Note:** The setting of the analog input range another than the nominal (voltage or current magnifier) leads to a decrease of measurement accuracy.

The type of output signal is set automatically as analog. One must write the name and the channel description in, and set parameters of the output range (Precision, Min, Max, and Unit)

One can also select the option of parameter copying from the measuring input into the output.

#### b. Universal analog inputs: AI 1 ... AI 16:

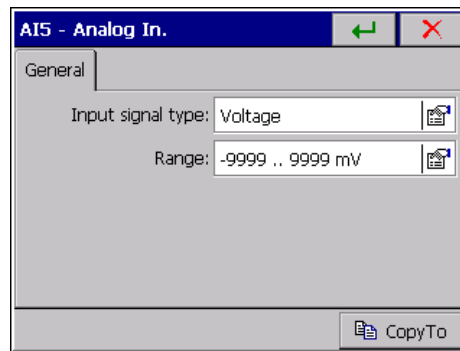
<b>Configuration: AI8 – Analog inputs</b>			
<b>General</b>	<b>Type of input signal:</b>	<i>Voltage</i>	<b>Selection of signal type</b>
	<b>Range:</b>	-9999...9999	<b>Range edition</b>

#### - Selection of signal type:

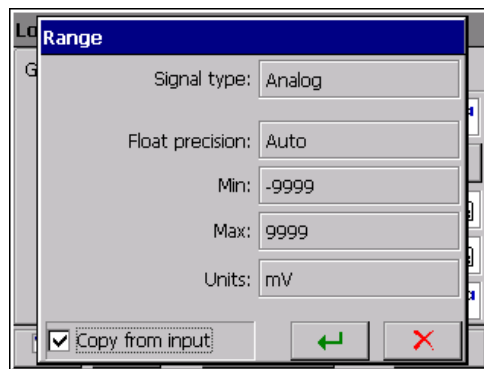
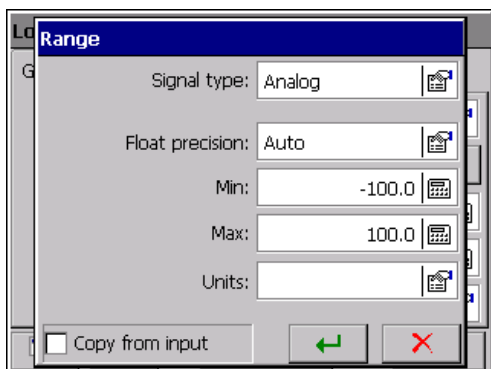
- Parameters of the measuring system for the signal: voltage and current:

Input signal	Signal symbol in the menu	Measuring range	Minimal sub-range
Voltage	mV	0... ± 9999 mV	5 mV
Current	mA	0...± 20 mA	1 mA

Choose the type of the output signal and set the input Signal. The value of the upper range limit (Max) must be higher than the value of the lower limit value (Min), preserving its minimal span acc. the table as above.



Next, write the name and signal description in and set parameters of the output signal (Precision, Min, Max and unit). The signal type is set automatically as analog. One can also choose the option of parameter copying into the output from the measuring input.

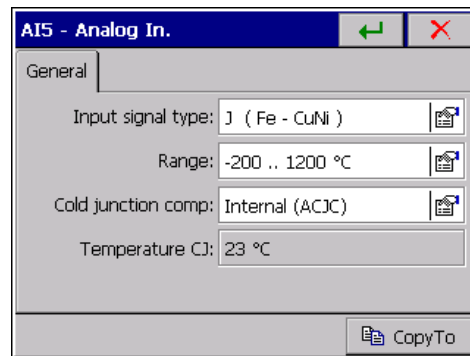


- **Parameters of the measuring system for temperature measurement through a thermocouple (TC):**

Input signal	Signal symbol in the menu	Measuring range	Minimal sub-range
<b>J</b> ( Fe – CuNi )	TC <b>J</b>	-200...1200 °C (-328...2192 °F)	100 °C (212 °F)
<b>K</b> ( NiCr – NiAl )	TC <b>K</b>	- 200...1370 °C (-328...2498 °F)	130 °C (266 °F)
<b>N</b> ( NiCrSi – Ni Si )	TC <b>N</b>	-200...1300 °C (-328...2372 °F)	200 °C (392 °F)
<b>E</b> ( NiCr-CuNi )	TC <b>E</b>	-200...1000 °C (-328...1832 °F)	100 °C (212 °F)
<b>R</b> ( PtRh13 - Pt )	TC <b>R</b>	0...1760 °C (32...3200 °F)	540 °C (1004 °F)
<b>S</b> ( PtRh10 - Pt )	TC <b>S</b>	0...1760 °C (32...3200 °F)	570 °C (1058 °F)
<b>T</b> ( Cu- CuNi )	TC <b>T</b>	-200...400 °C (-328...752 °F)	110 °C (230 °F)
<b>B</b> ( PtRh30 - PtRh6 )	TC <b>B</b>	400...1820 °C (752...3308 °F)	1000 °C (1832 °F)
Thermocouples of L ( <b>TXK</b> ) and K ( <b>TXA</b> ) type acc. to GOST standards.			



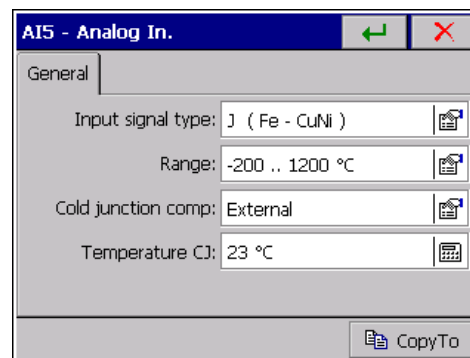
After selecting the signal type, set the upper (Max) and lower (Min) limit of the input signal. The value of the upper range limit (Max) must be higher than the value of the lower limit value (Min), preserving its minimal span acc. the table as above.



**Cold junction compensation:**

Defines the way of the thermocouple cold junction

- **Internal (ACJC):** Sets the self-acting cold junction compensation by the temperature sensor placed on the measuring package.
- **External:** the temperature of cold junction, 23°C set as a standard, can be changed.



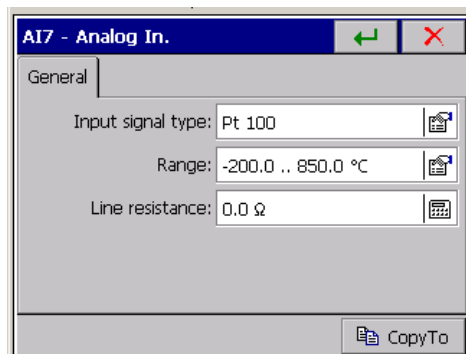
Next, write the name and signal description in and set parameters of the output signal (Precision, Min, Max and unit. The signal type is set automatically as analog.

One can also choose the option of parameter copying into the output from the measuring input.

- **Parameters of the measuring system for temperature measurement through a resistance thermometer (RTD)**

Input signal	Signal symbol in the menu	Measuring range	Minimal sub-range
Resistance thermometer (RTD):			
<b>Pt 100</b>	<b>Pt 100</b>	- 200...850 °C (-328...1562 °F)	50 °C (122 °F)
<b>Pt 500</b>	<b>Pt 500</b>	- 200...850 °C (-328...1562 °F)	
<b>Pt 1000</b>	<b>Pt 1000</b>	- 200...850 °C (-328...1562 °F)	
<b>Ni 100</b>	<b>Ni 100</b>	- 60...180 °C (-76...356 °F)	
<b>Ni 90,26</b>	<b>Ni 90,26 (P1)</b>	- 50...150 °C (-58...302 °F)	
<b>Cu 100</b>	<b>Cu 100</b>	-50... 180 °C (-58...356 °F)	
Thermometer resistances PT and Cu (GR21, 50P, 100P, 50M,100M) type acc. to GOST 6651-78 and GOST6651-94 standards.			

After selecting the signal type, set the upper (Max) and lower (Min) limit of the input signal. The value of the upper range limit (Max) must be higher than the value of the lower limit value (Min), preserving its minimal span acc. the table as above.



The way of the **Line Resistance** parameter programming depends on the way of the sensor connection.

- in a three-wire and two-wire connection with a balancing resistance, one must program the **0 Ω** value. Each another value will be treated as the line resistance and taken into consideration when calculating the measurement, what causes the error uprising.
- in a two-wire connection with an known resistance of the connecting line, program a value equal to the total resistance of both wires. The line resistance is introduced as a fixed-decimal value from the **000.0 ... 100.0 Ω** interval.

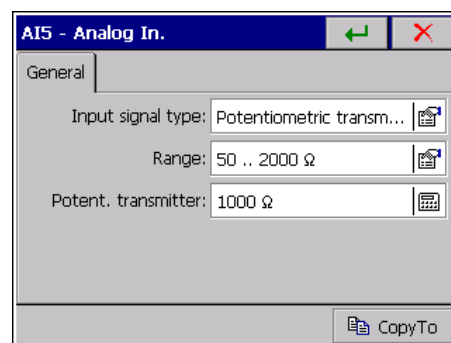
Next, write the name and channel description, and set parameters of the output range (Precision, Min, Max, and Unit). The signal type is automatically set as analog.

One can also choose the option of parameter copying into the output from the measuring input.

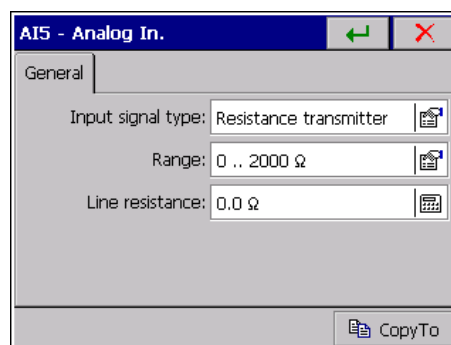
- **Parameters of the measuring system for resistance measurement through a resistance transmitter or a potentiometric transmitter:**

Input signal	Signal symbol in the menu	Measuring range	Minimal sub-range
Potentiometric transmitter	Pot. transm.	0...2000 Ω	100 Ω
Resistance transmitter	Res. transm.	0...2000 Ω	100 Ω

After selecting the signal type, set the upper and lower input signal limit. The value of upper range limit (Max) must be higher than the lower limit value (Min) preserving its minimal span acc. to the table as above.



- For the **Potentiometric transmitter** range, program the true value of the transmitter resistance.
- For the **Resistance transmitter** range the programming way of the **Line resistance** parameter depends on the way of the transmitter connection:



- in a three-wire and two-wire connection with a balancing resistance, one must program the **0 Ω** value. Each of another value will be treated as the line resistance and taken into consideration when calculating the measurement, what causes the error uprising.
- in a two-wire connection with an known resistance of the connecting line, one must introduce a fixed-decimal value form the **000.0 ... 100.0 Ω** interval.

Next, set parameters of the output range ( Precision, Min, Max and Unit ). The signal type is set automatically as analog.

One can also chose the parameter copying option from the measuring input to the output.

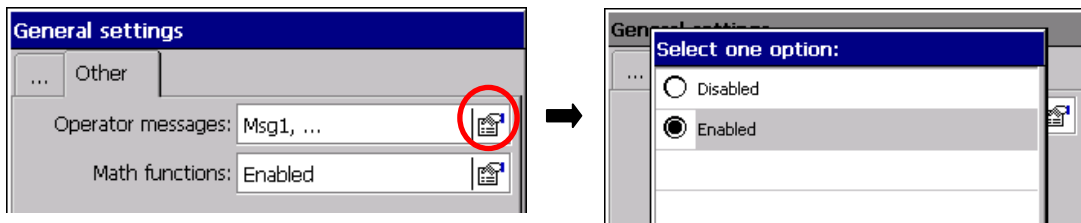
### 7.10.3.3 Mathematical functions MT 1..16, activation of the access

- **Enabling and disabling the mathematical function**

The edition and service of mathematical functions are accessible in recorders ordered with these functions (Order codes, see section 11)

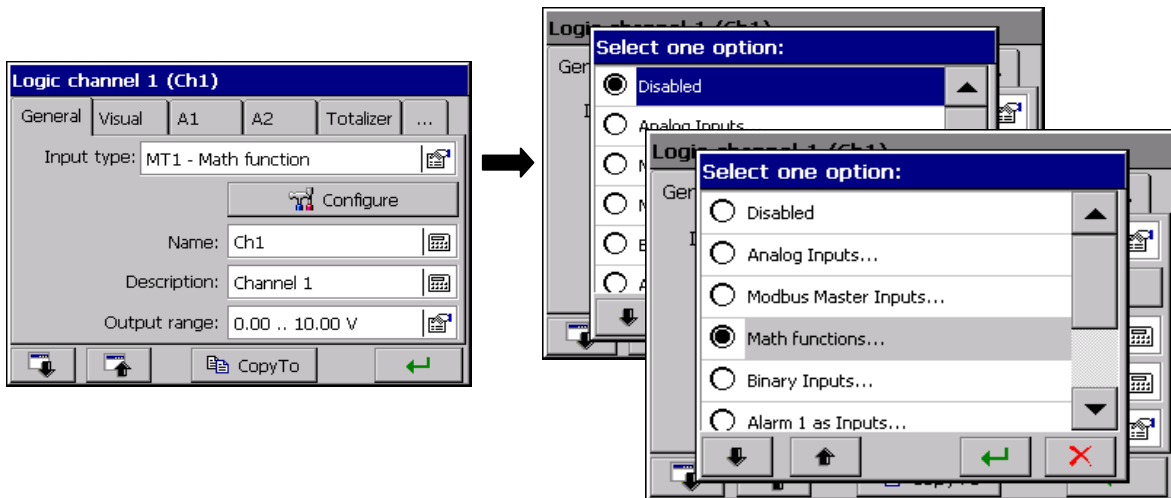
In recorders ordered without mathematical functions, the edition and service of these functions are accessible after the previous activation of the unique code for the given recorder. One can buy this code with the distributor of recorders.

In the recorder version with mathematical functions, one can **enable** (or **disable**) them in the **KD7 Control Panel** → **General settings** → **Extensions** menu:



Enabled/disabled service of mathematical functions follows after the configuration storage.

In the **KD7 Control Panel** → **Inputs** menu, the option to disable the selected logic channel or choice e-g, the mathematical function for this channel is accessible



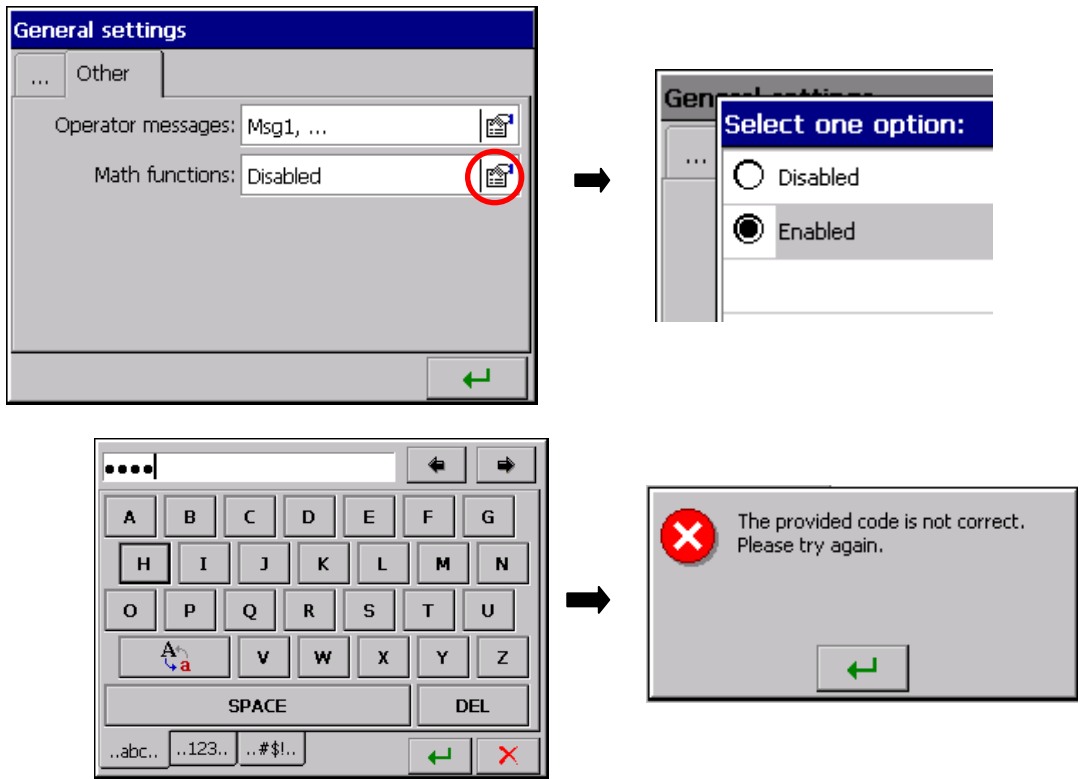
When mathematical functions are disabled (**KD7 Control Panel** → **General settings** → **Features**), the input option to the mathematical function edition is not visible in the logic channel configuration menu **KD7 Control Panel** → **Inputs**

- **Activation of mathematical functions in the recorder**



After selecting the  icon in the **KD7 Control Panel**, mathematical functions in the **Extensions** tab are disabled. After selecting the entry to option selection and marking, and

acceptation the **Active** option, one must introduce the delivered activation code in the open edition window.



When trying to accept an incorrect code, the window with a message about the erroneous code appears and after accepting this information, the return to the activation procedure of mathematical functions will return.

- **Configuration of mathematical functions**

For each logic channel of the recorder, one can select as the input signal source, one of 16 previously programmed mathematical functions, each with its proper name and a defined output range.

During the design process of a function, one must take care about the logic structure correctness of this function and take into consideration recounting coefficients for input units in the designed structure, in order to obtain function values in desirable output units.

The output range of the function should be defined **at least** in the range of its variability. (if this condition is not fulfilled, obtained results of the function recount will be erroneous).

Functions should be continuous and designed using accessible functors in minimized form, in the respect of the number of arithmetical operations.

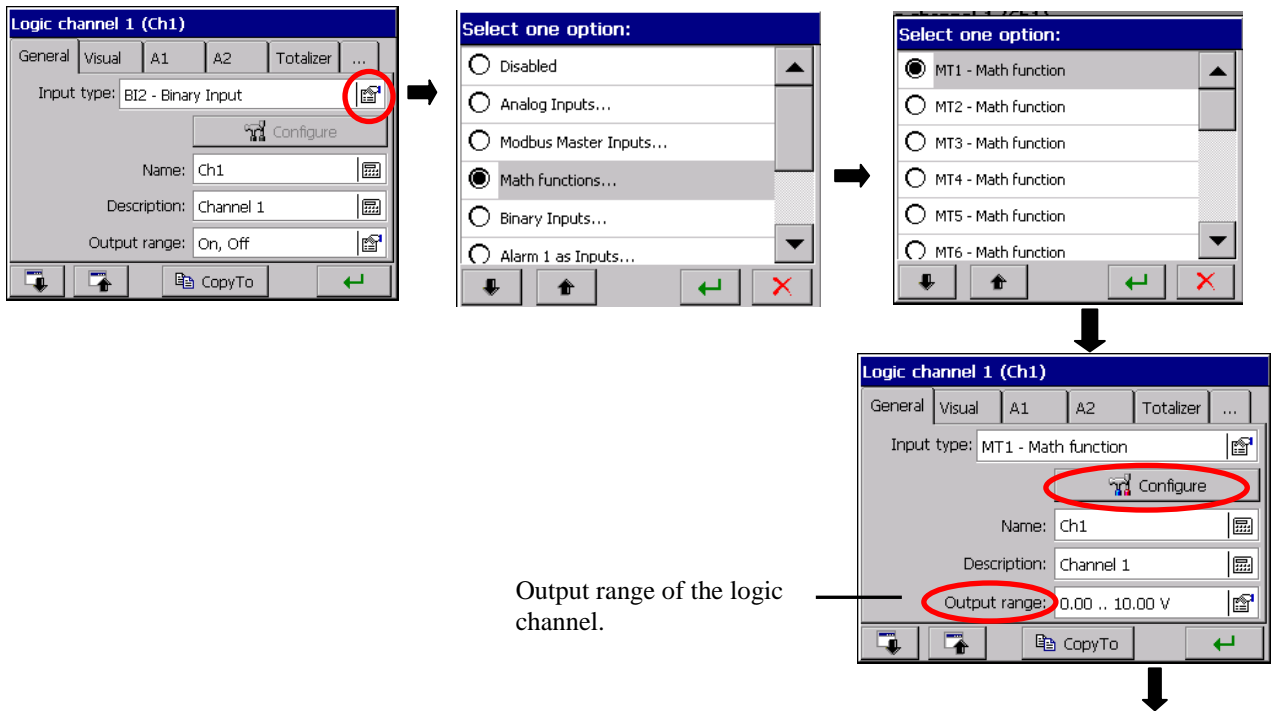
Symbols of these same inputs can occur repeatedly in the structure of the created function. The edited function can be composed maximally of 64 characters.

When the output range of the logic channel (for which the given mathematical function is the signal source) is different than the output range defined for the mathematical function, data displayed on the screen will be proportionally rescaled.

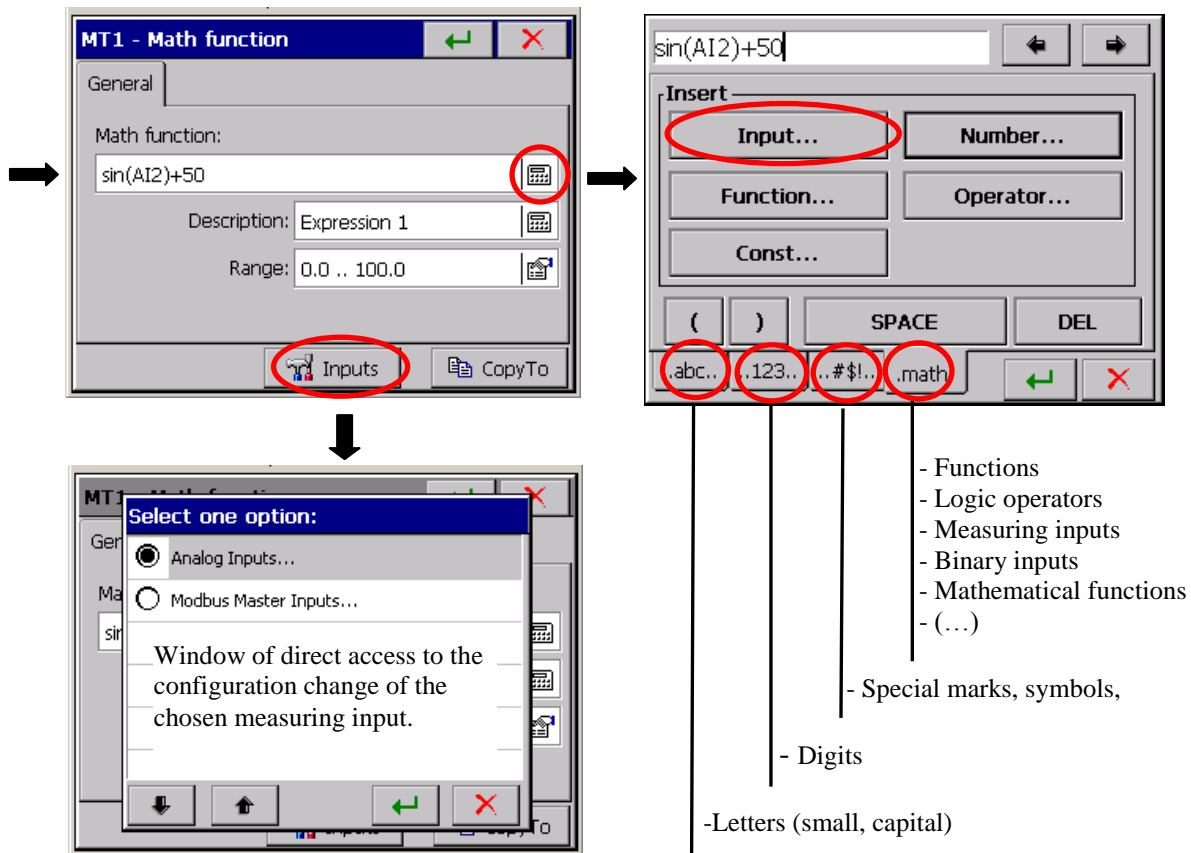
Each from logic channels can be disabled.

- **Configuration menu of mathematical functions**

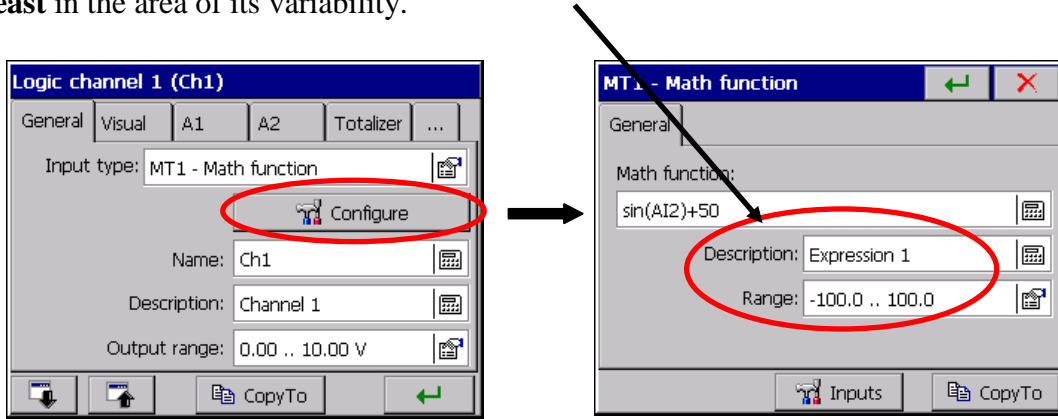
After entry into **KD7 Control Panel** → **Inputs** → **Mathematical functions (MT1..16)**, one can start to the edition of the selected function:



The data source for the configuration of mathematical functions are: Analog measuring inputs AI1..12, Binary inputs (BI1..16), Interface Modbus Master inputs (CI1..24), Alarms A1 and A2 in logic channels 1..32, Mathematical functions (MT1..16), Totalizers – integral or counter (TOTC1..32), Values of logic channels: Average (AVGC1..32), Minimal (MINC1..32) or Maximal (MAXC1..32) and functions, mathematic and logic operators (as below).



After the edition, write the description and the output function range. It should be determined **at least** in the area of its variability.

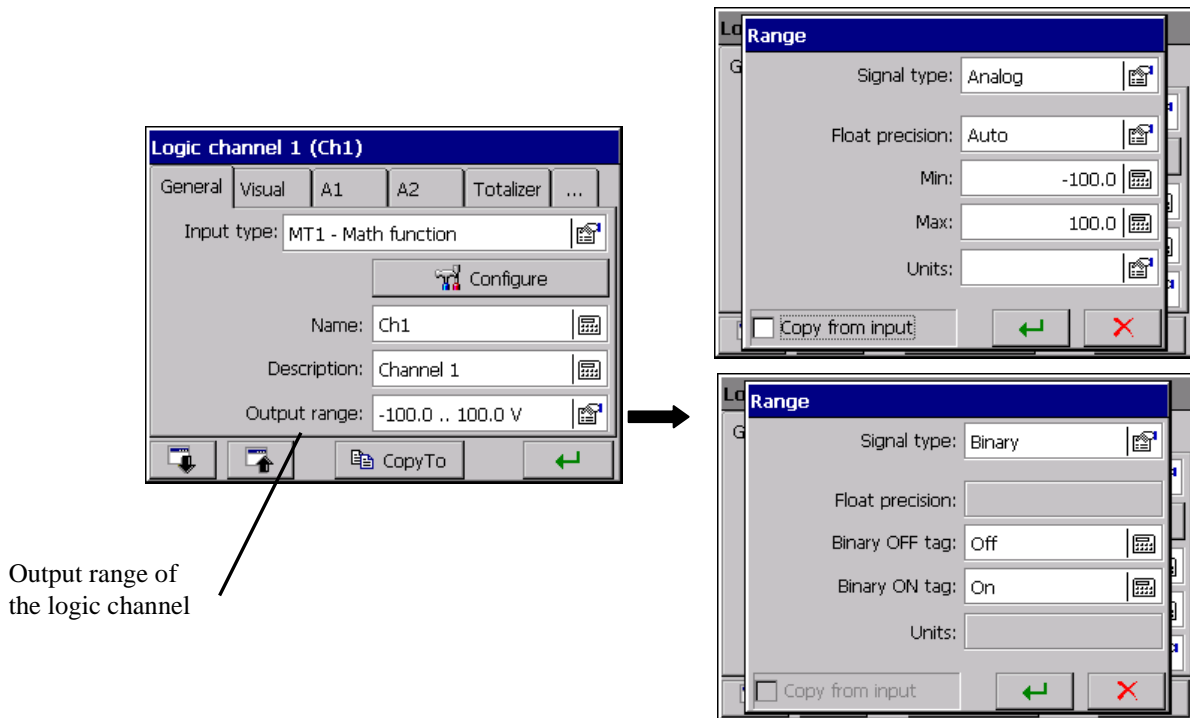


Next, write the name and channel description in, and set output parameters of the logic channel ( for which the function is the signal source): description, output range of the logic channel, signal type, precision, unit. One can set the signal type as analog or binary.

**Selection of analog signal type** means, that the signal of this output will be treated as continuous and the logic channel will be visualized and archived in this form.

**Selection of binary signal type** means, that the signal of this output will be converted into two output states 0/1 and the logic channel will be visualized and archived in this form.

One can also choose the option of parameter copying to the output from the measuring input.



Output range of the logic channel

When the output range from the logic channel (for which the given mathematical function is the signal source) is different than the output range determined for the mathematical function, data displayed on the screen will be proportionally rescaled.

## Mathematical and logic functions:

Function	Description
round(x)	Returns the value x rounded to the nearest integer
sin(x)	Sine of number x
asin(x)	Arc sine of number x
sinh(x)	Hyperbolic sine of number x
cos(x)	Cosine of number x
acos(x)	Arc cosine of number x
cosh(x)	Hyperbolic cosine of number x
tan(x)	Tangent of number x
atan(x)	Arc tangent of number x (in radians)
tanh(x)	Hyperbolic tangent of number x
sqrt(x)	Square root of number x
min(v1,v2,v3,...)	Minimal value from numbers v1,v2,v3...
max(v1,v2,v3,...)	Maximal value from numbers v1,v2,v3...
abs(x)	Absolute value
rand()	Return random number between <b>0</b> and <b>1</b>
rand(min, max)	Return random number between <b>min</b> and <b>max</b>
ceil(x)	Returns the smallest integer higher or equal x
floor(x)	Returns the highest integer smaller or equal x
log(x)	Natural logarithm from the number x
log10(x)	Decimal logarithm from the number x
avg(v1,v2,v3,...)	Mean value of numbers v1,v2,v3...
sum(v1,v2,v3,...)	Sum of numbers v1,v2,v3...
if(warunek, v1, v2)	Conditional expression. If the <b>condition</b> is <b>true</b> , the function returns <b>V1</b> , in the contrary it returns <b>v2</b> .
isNan(x)	Returns 1 when x has an indefinite value ( NaN)
isFinite(x)	Returns 1 when x has an infinite value and is not NaN
hex(hexNumber)	Conversion of a hexadecimal number into a decimal number, e.g. (F0) returns the value 240
bin(binNumber)	Conversion of a logic number into a decimal number, e.g. bin(0100) returns the value 4
isErr(value)	Returns 1 if the value is erroneous (e.g. measuring error)
date(year, month, day)	Returns the <b>date_time</b> value corresponding to the given date
time(hour, minute, sekond)	Returns the <b>date_time</b> value corresponding to the given time
day(date_time)	Returns the day of the month corresponding to the given <b>date_time</b>
hour(date_time)	Returns the hour corresponding to the given <b>date_time</b>
minute(date_time)	Returns the minute corresponding to the given <b>date_time</b>
second(date_time)	Returns the second corresponding to the given <b>date_time</b>
year(date_time)	Returns the year corresponding to the given <b>date_time</b>
month(date_time)	Returns the month corresponding to the given <b>date_time</b>
weekday(date_time)	Returns the day of the week corresponding to the given <b>date_time</b>
nowdate()	Returns the <b>date_time</b> value corresponding to the current date
nowtime()	Returns the <b>date_time</b> value corresponding to the current time.
status(value)	Returns status value given as parameter (correct values, sensor break, range exceeding...)

## Mathematical and logic operators:

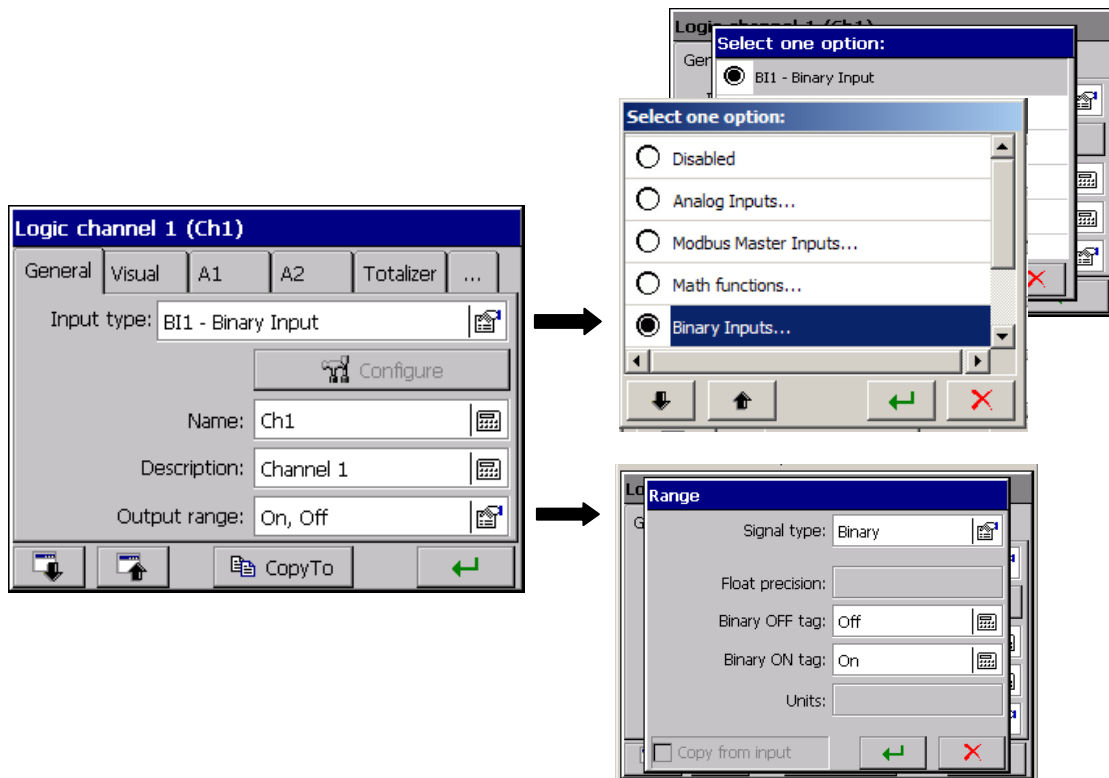
Operator	Function	Description
+	$x + y$	Addition
-	$x - y$	Subtraction
*	$x * y$	Multiplication
/	$x / y$	Division
^	$x ^ y$	Raising to a power
-	-x	Negation of the number sign
%	$x \% y$	Modulo, returns the fractional part of the division operation $x/y$
>	$x > y$	Logic operator higher than. Returns 1 if <b>true</b> and 0 if <b>false</b>
<	$x < y$	Logic operator smaller than. Returns 1 if <b>true</b> and 0 if <b>false</b>
>=	$x >= y$	Logic operator higher or equal. Returns 1 if <b>true</b> and 0 if <b>false</b>
<=	$x <= y$	Logic operator smaller or equal. Returns 1 if <b>true</b> and 0 if <b>false</b>
!=	$x != y$	Different logic operator. Returns 1 if <b>true</b> and 0 if <b>false</b> .
==	$x == y$	Equal logic operator. Returns if <b>true</b> and 0 if <b>false</b> .
&	$x \& y$	Logic product (conjunction). Returns if <b>true</b> and 0 if <b>false</b> .
	$x   y$	Logic sum (alternative). Returns if <b>true</b> and 0 if <b>false</b> .
!	!x	Logic negation. Returns 1 if x equal 0, in the contrary, returns 0.

### Notes:

- Trigonometric functions operate on radians,
- The **date\_time** value is the representation of the date and time in the „OLE Automation date” format. In this format, the date and time are represented as the number of seconds since 30 December 1899 divided by 86400 (number of seconds in a day).
- Logic values **true** and **false** – a value different from zero is treated as the logic value **true**. a value equal 0 is treated as the logic value **false**.
- Functions **min**, **max**, **sum**, **avg**, and all others operate on actual values, e.g. the **sum** functions gives in result the sum of actual values given as parameters and not the sum of these value in time.

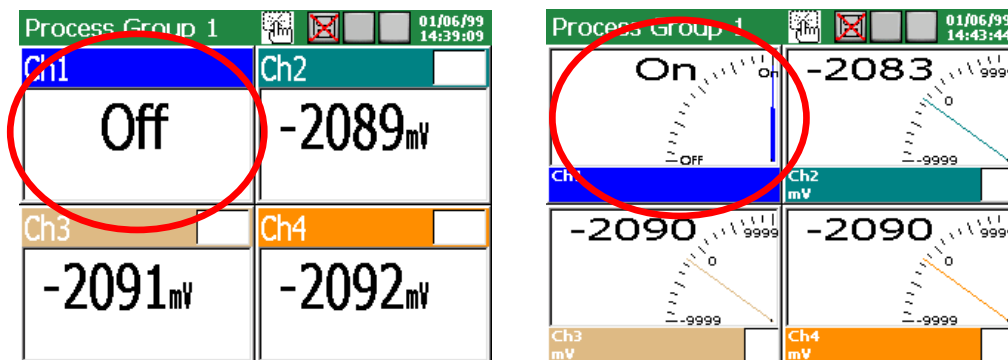


### 7.10.3.4. Binary input BI 1..16



For the logic channel as the input signal, one can select one of the accessible binary inputs **BI 1..BI 16**

The signal type of the output channel is set automatically as **binary** and will be visualized and archived in this form. (see section 8.2).



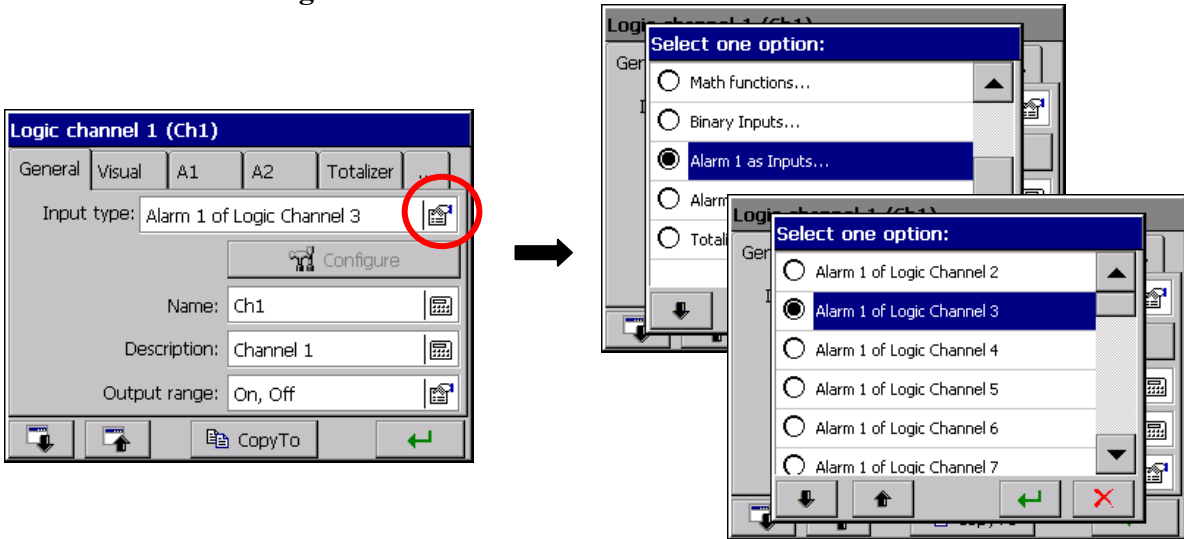
Write the name and logic channel description in the **General** tab and the description of output logic states 1 and 0 of the channel (as standard, it is **ON** and **OFF**).

Programming of alarm parameters in overlaps **A1** i **A2** is disabled. The parameter programming in the **Totalizer** tab, as in section 8.5.3 „Totalizer programming” (Counter/Integral).

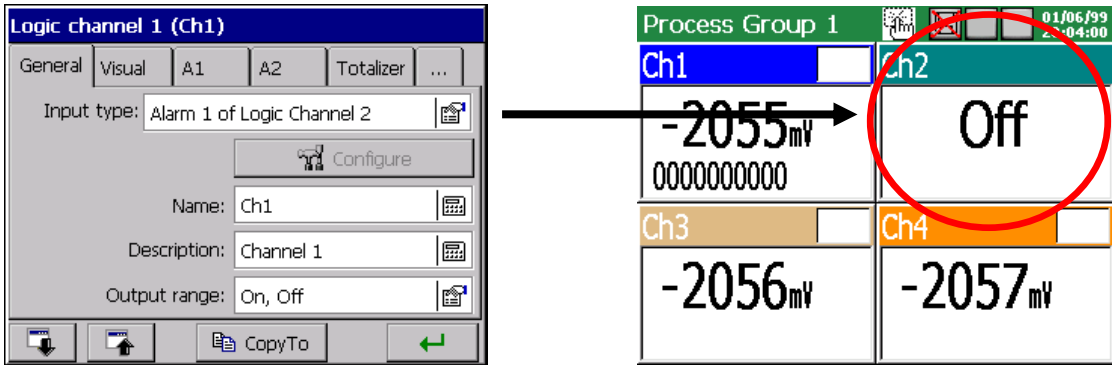
Parameters set in the selected logic channel in the **Common** tab concern all remaining channels, see section 8.5.1 „Programming of general parameters, visualization and common”.

In each of other logic channel, they can be modified.

### 7.10.3.5. Alarm of the logic channel 1...32



For the given logic channel 1..32, one can choose as the input, one of two alarms from another logic channel.  
 The type of output signal, for this channel, is set automatically as binary and it will be visualized and archived in this form (see section 8.2).

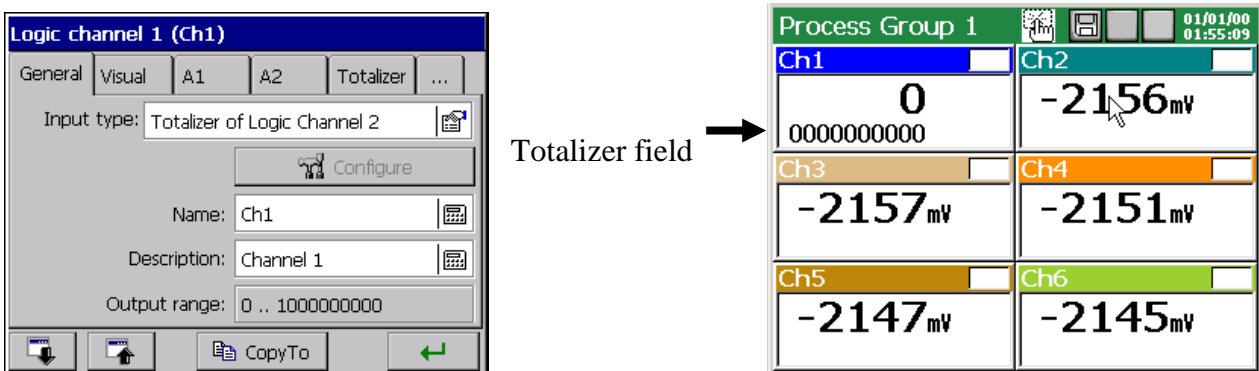


In the **General** tab, one can write the name and logic channel description, and the description of its output logic states **1** and **0** (as standard, it is **ON** and **OFF**).

The access for programming alarms **A1** and **A2** is disabled. That concerns alarms A1 and A2 of the chosen logic channel for which as the input, one of alarms from another logic channel or one of the logic inputs is chosen..

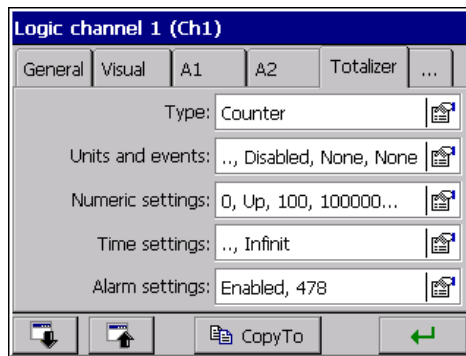
For programming parameters in the **Visual** and **General** tab see section 7.10.2.

### 7.10.3.6 Totalizer of the logic channel 1..32



For the chosen logic channel, one can select as the input, the totalizer (Counter or Integral) programmed in another logic channel.

The programming of parameters in the **Totalizer** tab must be carried out acc. to the description as in section 8.5.3. „ Totalizer programming (Counter / Integral)”.



In the **General** tab one can write the name and description of the logic channel. The parameter programming for **Visual**, **Alarm** and **Common** see section 7.10.2.

### 7.11 Configuration and service of event logs

Following kinds of event logs are accessible in the recorder:

- Audit log
- Alarm log
- Statistics log

In the **Audit log**, information concerning the recorder current service are stored: kind of event, time and date of appearance.

Audit log				
No.	Diary	Time	Date	
38	Configuration Changed	06:35:26	29/08/00	
37	Control Panel Closed	06:35:15	29/08/00	
36	Control Panel Opened	06:34:52	29/08/00	
35	Control Panel Closed	06:34:30	29/08/00	
34	Storage Card Inserted	06:24:00	29/08/00	
33	Storage Card Removed	06:23:15	29/08/00	

Maximal capacity of the Audit log is about 900 records. **After exceeding this capacity, the log is overwritten**

Operator’s information (see chapter 7.12) and information related to programmed alarm states are stored in the **Alarm log**: kind of alarm and alarm value, alarm source, time and date of appearance.

Alarm log				
No.	Alarm tag	Source	Time	Date
3	Operator Message (Ms...	-	19:55:13	30/03/08
2	Al. Rng. Off - Off (4.0...	Ch1	19:53:51	30/03/08
1	Al. Rng. Off - On (4.1...	Ch1	19:53:24	30/03/08

Maximal capacity of the Alarm log is about 700 records. **After exceeding this capacity, the log is overwritten.**

In the **Statistics log**, information concerning the exceeding of programmed alarm states are stored: record number, information about current totalizer parameters – Current, Min, Max, Mean value, and Time and Date of the record.

Statistics log			
No.	Log	Time	Date
3	Ch1: Totalizer Periodic Call Tot.: 0000000000 Min: -100.0, Max: 100.0, Avg: 1....	07:44:00	29/08/00
2	Ch1: Totalizer Periodic Call Tot.: 0000000000 Min: -100.0, Max: 100.0, Avg: -1...	07:43:00	29/08/00

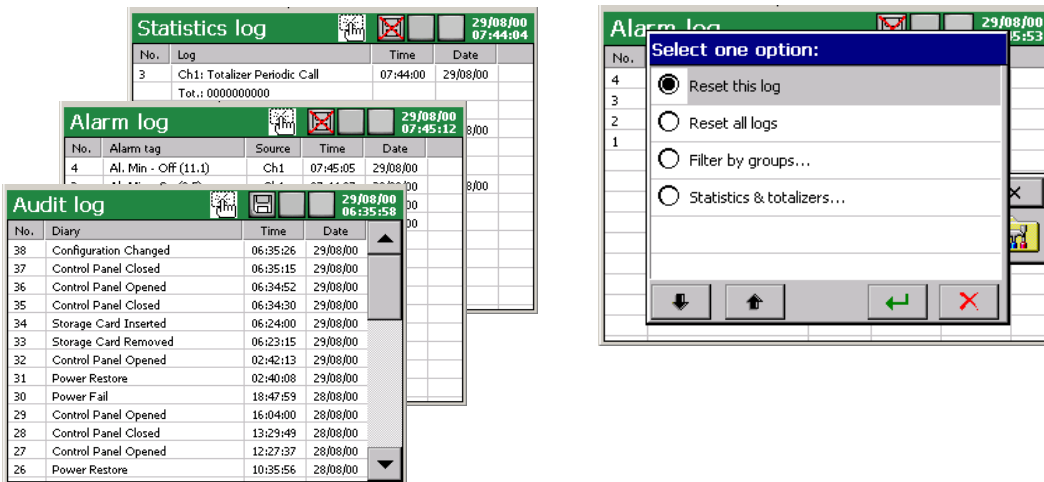
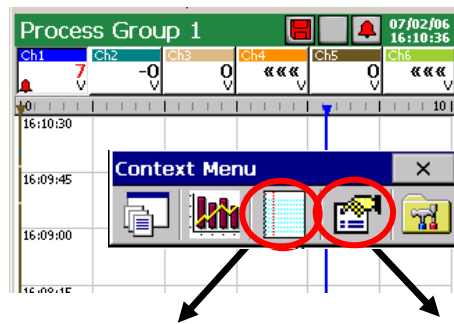
Maximal capacity of the Statistic log is about 400 records.  
**After exceeding this capacity, the log is overwritten.**

In the **Archive mode**, it is possible to view archived data from binary files stored on the CF card.

Archive mode			
File browser			
No.	Date	Time	DCJ[mA]
4	2011-08-04	09:40:30	0.00
5	2011-08-04	09:40:40	0.00
6	2011-08-04	09:40:50	0.00

After selecting file it is possible to view next / previous records using the arrows.

### 7.11.1 Review and service of event logs



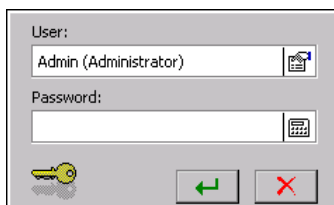
After pressing the screen, during the visualization of measuring data, the **Context menu** is displayed.



The pressure of the icon causes the view appearance of one of the event log and switching the successive views of other logs.

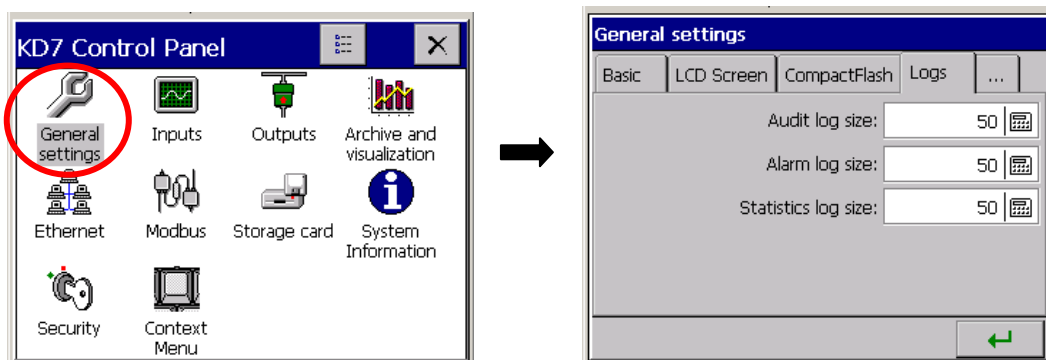


The pressure of the icon during the review of one of the log causes the display, after the previous confirmation of the user's password (if it was programmed), the screen of the service option of the given log: clearing the log/all logs, filtration of data related to the selected group. For Statistics and Totalizers, following options are accessible: Reset All/selected..., Pause ON All/selected, Pause Off All/selected.

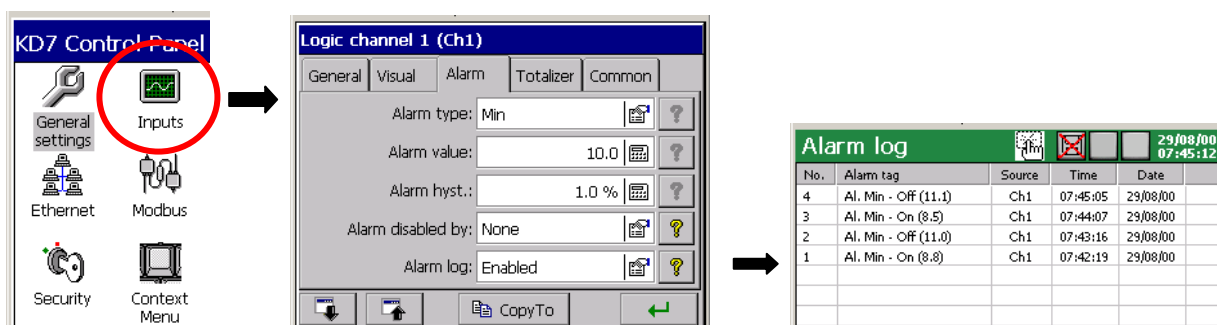


### 7.11.2 Programming of event logs

1. Setting of the last records number to logs (Audit, Alarm and Statistics) shown on the recorder screen.



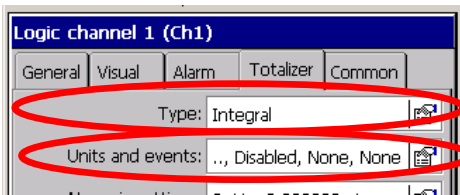
2. Setting in the **Logic channel [1...32]** the record of events to the alarm log (Enabled/Disabled).



When selecting the record option: **Disabled** – messages will not appear in the log.  
 When selecting the record option: **Enabled** – messages will displayed in the log.

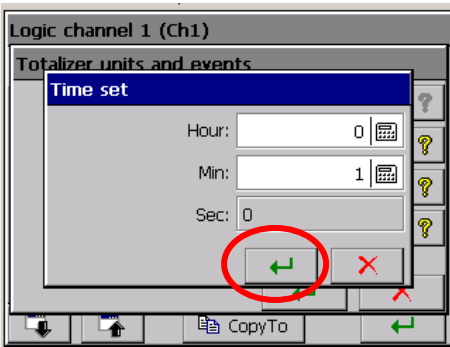
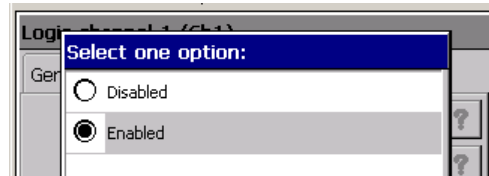
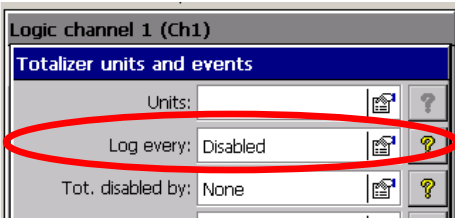
3. Setting in the **Logic channel [1...32]** the option of data storage from the Totalizer to the Statistics log.
  - **Enabled/Disabled** to the Statistics log data records from the Totalizer (Counter or Integral)
  - setting of the time interval of data storage, if the option **Enabled** of the record as been selected as above.



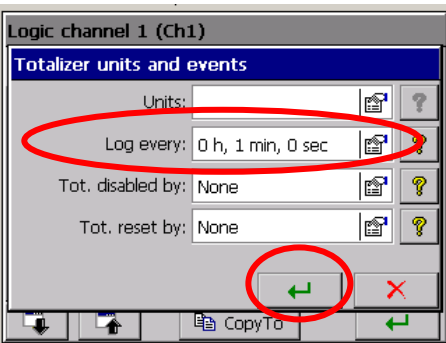


- Select the Totalizer type (Integral or Counter)

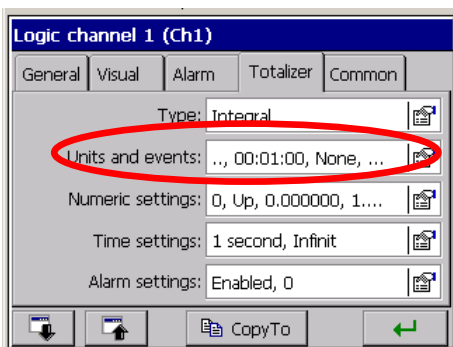
- After choosing the **Unit and events** menu in the open window **Totalizer units and events** select the option **Enabled** for the **Record to the log** menu.



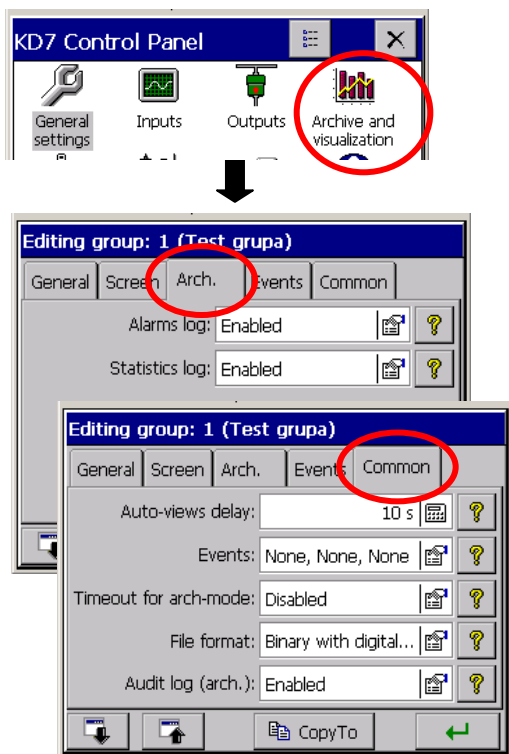
- The window **Time setting** of data storage to the Statistics log will be opening. After accepting settings, data will be stored in the window **Totalizer units and events** in the **Record to the log** menu.



- After accepting settings, data will be introduced to the **Totalizer** tag in the **Logic channel [n]** window in the **Unit and Events** menu.



4. Setting in the measuring group [1...4] the archive option of data from alarm and statistics logs.



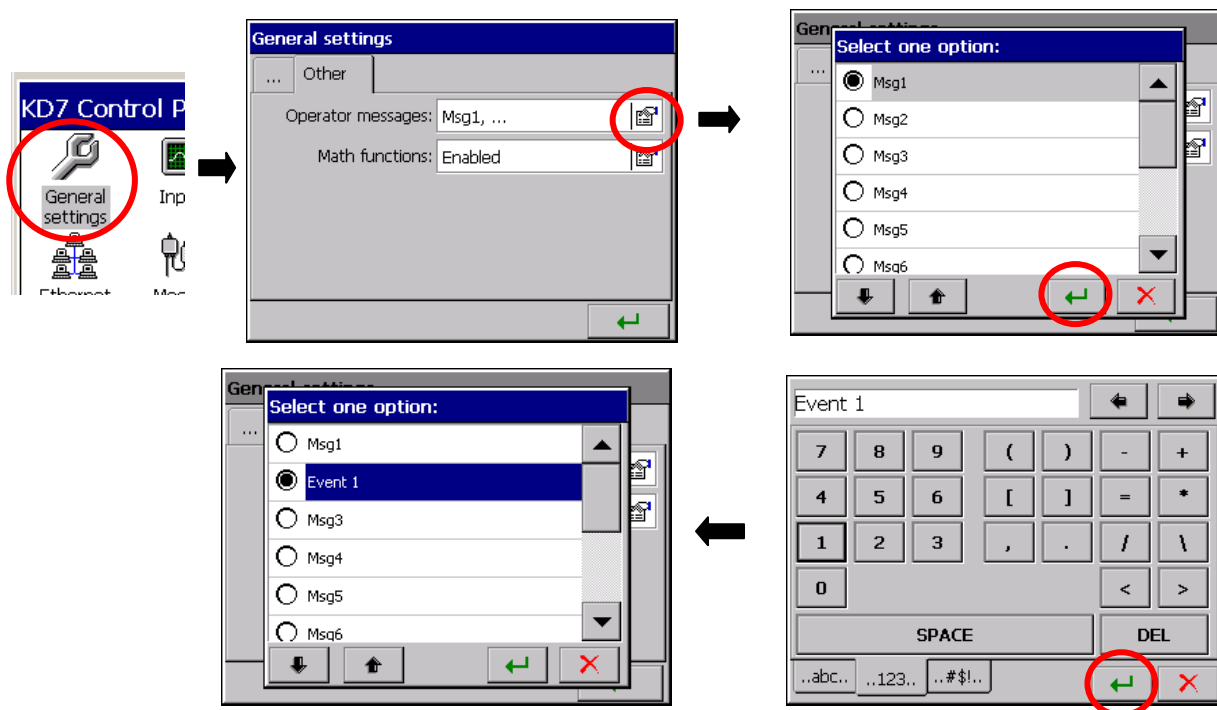
In the **Arch.** tag of the edited measuring group for the **Alarm log** and the **Statistics log**, and in the **Common** tag for the **Audit log**, one can set up the option of data archiving:

**Enabled** – the log is displayed and stored in the CF memory card.

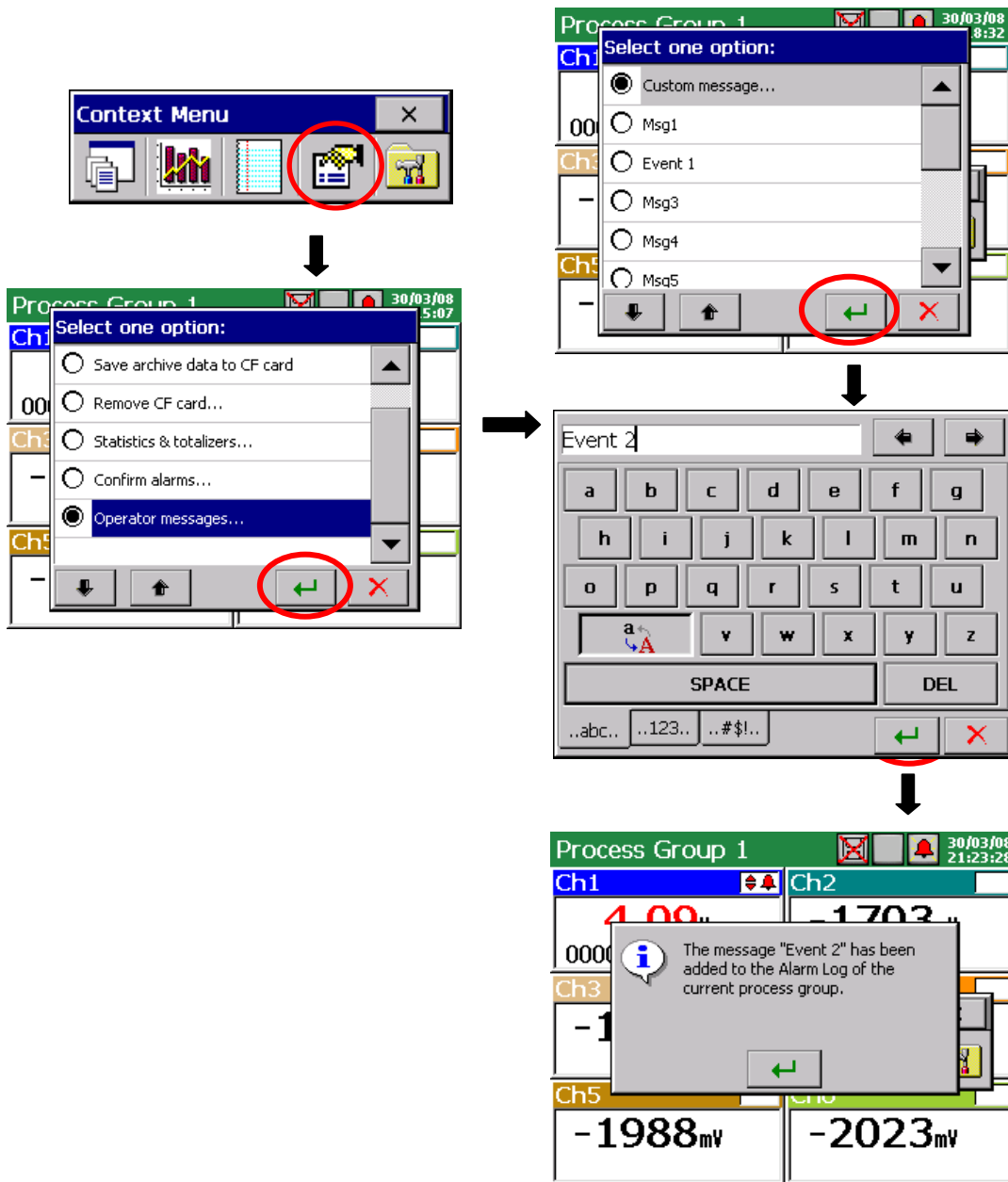
**Disabled** – the log is displayed but data from the log are not stored in the CF memory card.

### 7.12 Edition of operator's messages

In the recorder configuration menu, one can program for the given measuring process up to 10 constant messages (marked preliminary as **Msg1...Msg10**), which during the work in measuring and recording mode, as the need arises, can be stored by the operator in the alarm log. The change of the message contents is possible only from the level of the recorder configuration menu.



During the recorder operation in the measuring and recording mode, in the option: **Context menu - Operator's messages - Choose the option - Own message**, one can edit a message which is currently stored in the message log without the need to transit to the recorder configuration menu.



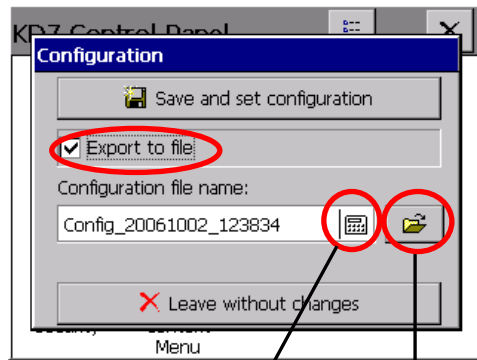
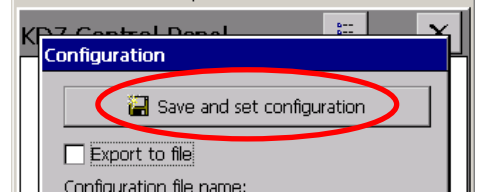
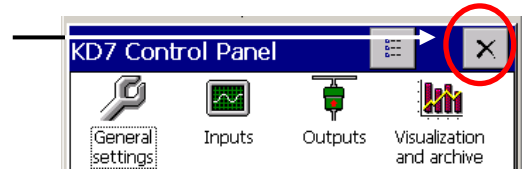


### 7.13 Exit from the recorder configuration

After finishing the recorder configuration, one must close **KD7 Control Panel**.

After pressing the output button from the configuration, the window to select the option of the configuration file storage selection is open:

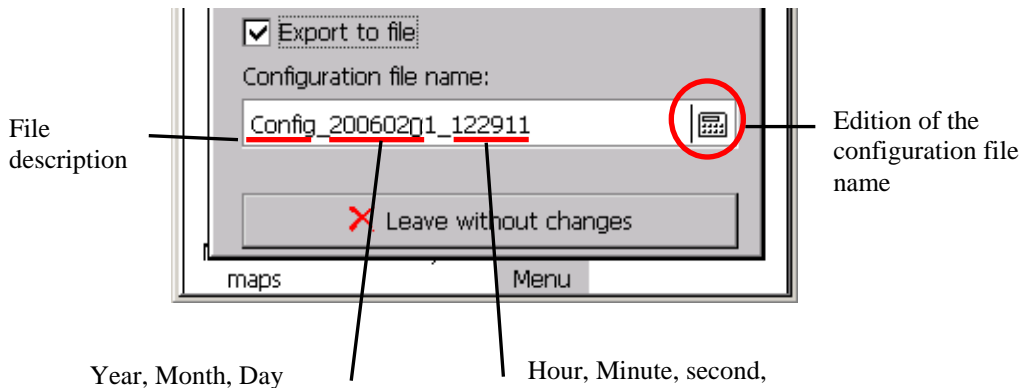
- After selecting the **Save and set configuration** button.
- When simultaneously the **Export to file** option is marked, the configuration file will be stored in the recorder memory and in the CF card, in the file with the given name in the window. The name can be changed into another, after the entry into its edition.
- One can also choose any of the configuration file stored in the CF card, and under its name store a new configuration file.
- After selecting the **Leave without changes** button, changes carried out in the control panel menu are not recorded, the recorder programming state remains without changes.



Edition of the name of configuration file

Selection of a file from stored in the CF card

Structure of the default name of the configuration file:



**Note:**


1. The configuration file is unique for the given recorder hardware configuration and cannot be transferred into another recorder with another equipment.
2. One can set in the recorder, the configuration of parameters for various technological processes and store for them proper configuration files ( with proper names). Applying them, one can quickly adapt the recorder to current user's needs.
3. One can also prepare configuration files in the PC computer through the KD7 Setup program (see section 9.2)

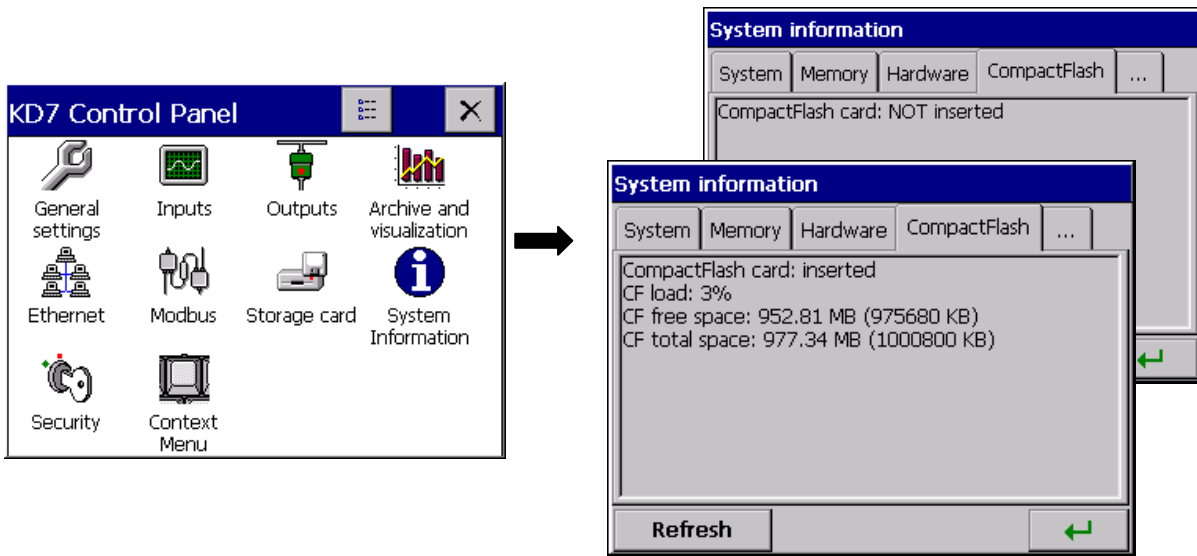
## 8. SELECTED ELEMENTS OF THE KD7 RECORDER CURRENT SERVICE

### 8.1 CompactFlash memory card


For the data storage in the KD7 recorder, one can use CompactFlash memory cards with a capacity from 16 MB up to 4 GB.

#### 8.1.1 Information about the CF memory card.

After selecting in the **KD7 Control Panel** window, the  icon in the **Systemic information – CompactFlash** tab, the information is given about the lack of the memory card in the recorder or when it is introduced into the recorder, data about the current filling state of the card, free place to store and total card capacity.

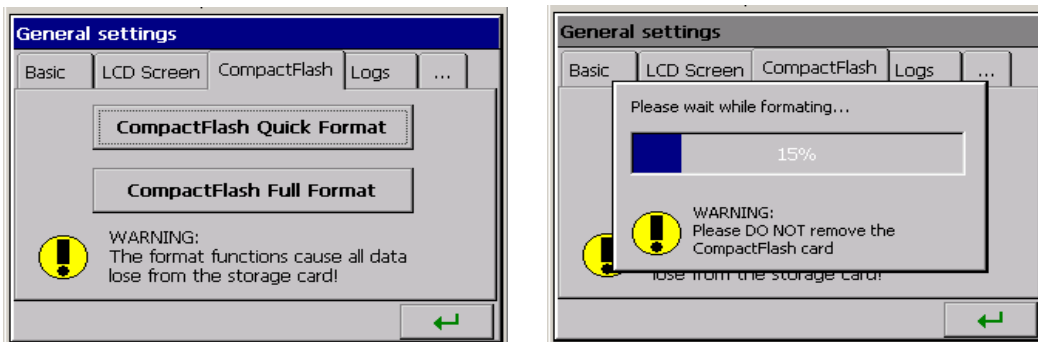


#### 8.1.2 Formatting of the CF card

After selecting the  icon in the **KD7 Control Panel**, in the **CompactFlash** tab of the **General Settings** window, one can choose options of formatting functions:

**Quick formatting of CF card** or **Full formatting of CF card**.

After confirming the selection, the formatting procedure of the CompactFlash memory card will begin.



**QUICK FORMATTING OF THE PC CARD** – deletes all files from the card, but do not scan cards in order to search damaged sectors. Quick formatting options must be selected when the card has been already formatted and we have the certainty that it is not damaged.

**FULL FORMATTING OF THE CF CARD** – deletes all files from the card and prepare the card to store information in it. This is followed by the check of the actual card state, physical and logic division of the card area into sectors, appropriate markings are given to them and a file system is created.

During the CF card formatting, the LED diode on the frontal plate changes its colour from green into red (see section 8.1.2 ).

### 8.1.3 Data storage on the CF memory card (card storage capacity)

During the recorder operation, when measuring data are stored in the recorder memory, the LED diode placed on the KD7 frontal panel, lights in green. When data from the recorder memory are reproduced on the CF card, the LED diode placed on the KD7 frontal plate changes the colour from green into red.

**During data recording on the CF card, one must not pull it out from the recorder. The removal of the card can cause an irreversible loss of all data stored on the memory card. One can remove the card only after finishing the data storage on it (green color of the LED diode).**



Data are stored on the CF card in successive files, each file has a capacity allowing to open in Excel program. Files are generated separately for each logic channel group.

When introducing changes in the recorder configuration, all data from the buffer ( stored in it at the original configuration) are rewritten into the hereto open files of logic channel groups and new data, obtained already after introducing changes in the configuration, are stored in new open files of groups.



After exceeding 90% of the CF card capacity storage level, (when the icon on the KD7 screen has the red colour).



**It is recommended** to transfer data from the memory card to the PC computer as fast as possible, format the card or replace for another (see section 8.1.2), not recorded and not formatted

**- Rough time of the full CF card storage**

Depending on:

- rated CF card capacity
- parameters of data storage (storage period, number of groups, number of channels in the group, data storage format: textual, logic).

Card capacity	Number of groups	Number of active channels in the group	Storage period	Time of the card filling (hours/days)			
				Textual format		Logic format	
				Hours	Days	Hours	Days
512 MB	4	6	1 s	280	11	900	38
			5 s	1400	58	4600	190
			10 s	2800	117	9300	380
			1 min	16900	700	56000	2300
1GB	4	6	1 s	560	23	1800	77
			5 s	2800	117	9300	380
			10 s	5600	230	18000	770
			1 min	33800	1400	110000	4600

**After exceeding the nominal capacity of the CF card, measuring data will be stored in the KD7 buffer. During the data storage into the buffer, one must replace the CF card by another, formatted card. If the card is not be replaced on time after filling the buffer, data will be overwritten.**



**The minimal working time of the recorder** after which the buffer filling follows, is equal ca 8.5 hours, for 4 measuring groups of 6 channels, each which a 1 sec. storage period.

**Note:** Using The Program **KD Connect** (see section 9.1) , one can copy data in the PC, from the inserted CF card in the recorder and its full clearing.

During the recorder writer, data from each measuring group (see p. 8.2.1) are stored in the KD7 buffer.

Data are not currently recorded to the file in the CF card for the reason of possibility to quick damage of the card. The period of data recording from the given measuring group in the CF card is the multiple of the programmed storage period for this group and can last even several months.

Considering that in the meantime the access to the CF card with stored all current measuring data on it, before its extraction from the KD7 recorder, one must start the option **Save archive data to CF card** (see section 8.1.6) – Then follows the rewrite of the current buffer contents on the CF card. If there is the need, these data were automatically rewritten on the CF card, e.g. in the defined interval of time then, one can apply the event **Save data on CF** (see section 8.2)

### 8.1.4 Visualization of the CF card state on the screen

- Lack of CF card in the recorder

Lack of CF card in the recorder



- The CF card is inserted in the recorder

Index of CF card presence, the card is not filled.



- Exceeding of the 90% recording level of the CF card capacity

Red color, exceeding of the 90% storage level of the CF card capacity .

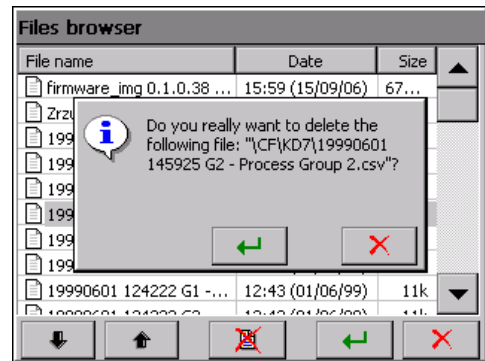
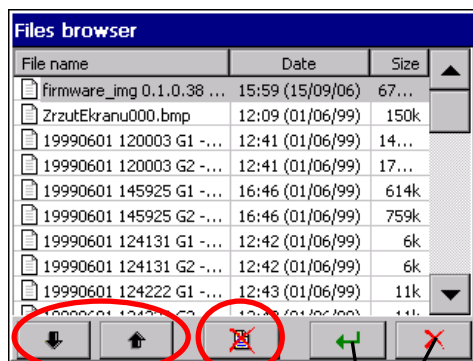


### 8.1.5 Review and erasing of files from the CF card



After selecting the Storage card icon in the **KD7 Control Panel** window, names of files stored on the CF memory card are displayed in the **Files Browser** window.

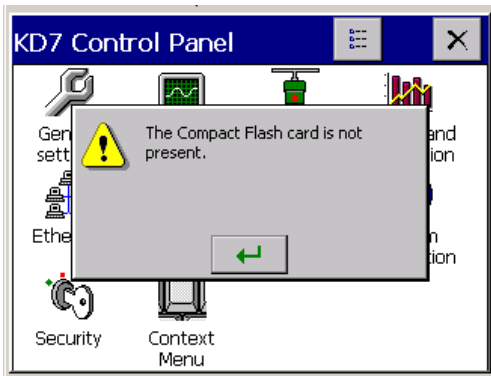
After selecting the given file and confirming the selection, this file is deleted from the CF card.



File Selection

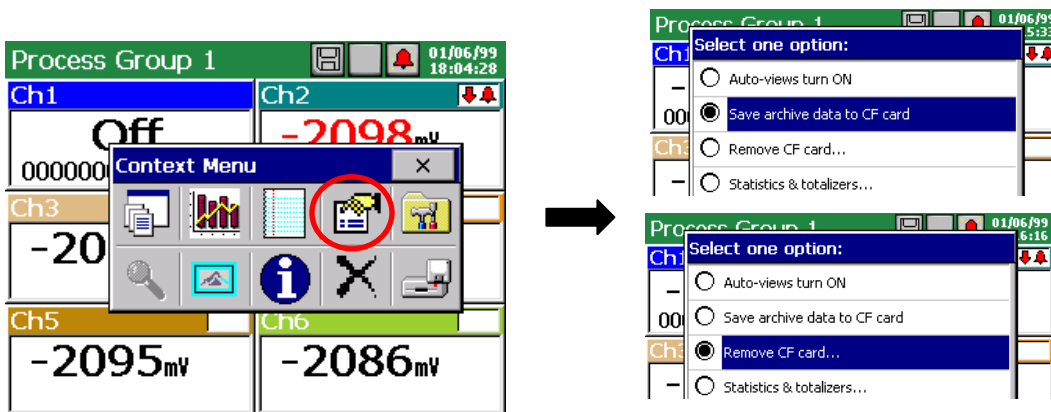
Erasing of the selected file


Exit from the menu Return to the KD7 Control Panel



If the card is not inserted into the recorder or is not formatted, a message informing about its lack is displayed

### 8.1.6 Removal/replacement of the CF card, storage of archive data



In order to take out safely the CF card from the recorder (without the loss of measuring data), one must open the **Context menu** window, (by pressing the screen with a finger), press the  icon of the option selection in it, and mark **Remove CF card** in the **Select one option** open window.

After selecting this option, the complement of data will be made automatically on the card with new data assembled (stored) in the internal buffer (it is not necessary to select the **Save archive data to CF** before choosing the **Remove CF card option**) and next, the storage on the card will be locked till the acceptance time of the displayed message. Before the message acceptance, one can replace the card for a new one.



The removal of a CF card without the previous execution of described above procedures can cause the loss of all measuring data.



The option **Save archive data to CF card** forces the rewriting of the newest data from the recorder internal memory (data buffer) on the CF card. After rewriting these archive data on the CF card, the storage to the buffer follows acc. to current settings

**Taking in consideration the guaranteed life time of the CF card by its producer, it is not recommended to use too often the Archive data write on the card.**



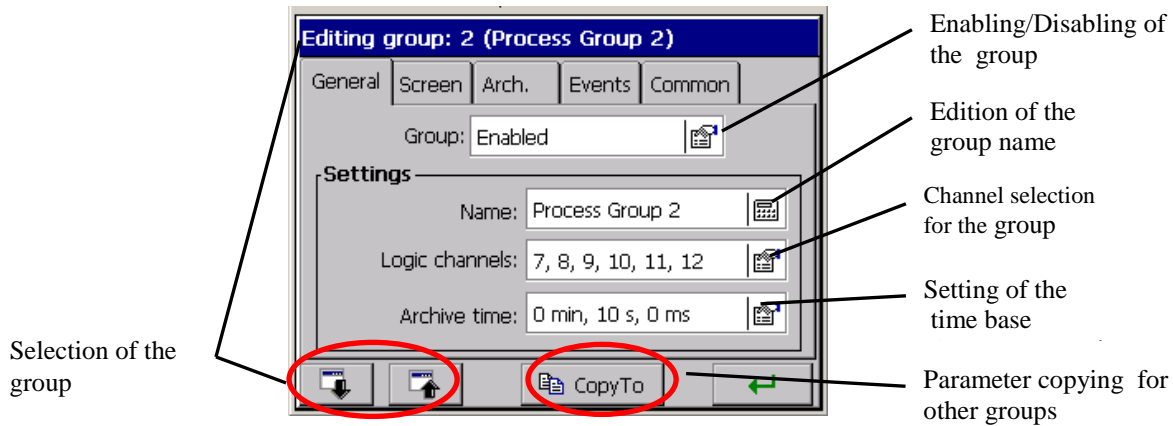
## 8.2. Programming of logic channel groups 1...4

For the visualization and analysis of measuring data related e.g. with the defined technological process, one can connect logic channels in 1..4 measuring groups (each with 1 .. 6 channels) for which an individual set of parameters is settled.

After selecting in the **KD7 Control Panel** window the icon



, the window of channel group edition is open.



### 8.2.1 Programming and servicing of screens

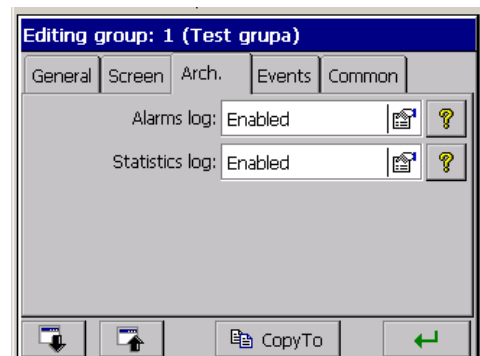
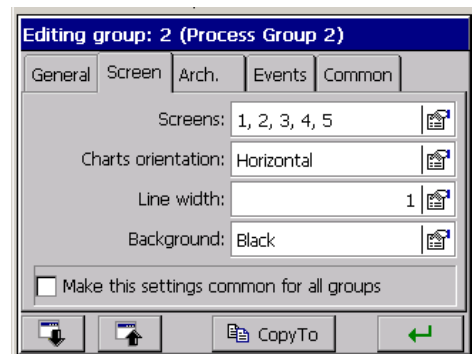
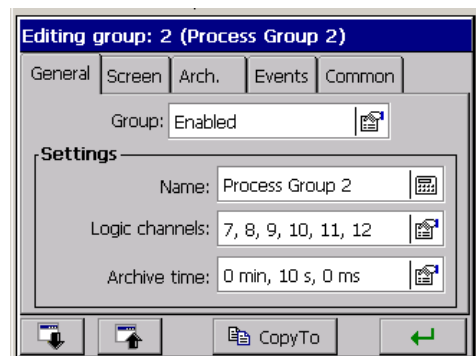
For each edited group of logic channels (**..KD7 Control Panel** → **Visualization and Archiving** → **Edited group**) in the **General** tab, one can select 1...6 logic channels for presentation from 32 accessible channels in the recorder, write the group name and set The time base for the group.

In the **Screen** tab, one can chose screen views for presentation in the given group (digital view, linear analog, statistics, bargraphs), the screen orientation (horizontal or vertical, the line thickness for the line screen and the screen background (black or white).

The working state of the **Alarm log** and **Statistic log** is set in the **Arch.** Tab. When the log is set as **Disabled**, it is displayed on the screen but it is not saved on the CF card. When it is set as **Enabled**, it is displayed on the screen and saved on the CF card (see section 7.11).

In the **Event** tab following parameter are set:

- **Archive disabled by:**  
Archiving of measuring data of the group is Disabled by the logic state 1 (ON) of the selected logic channel, see the **Note** below.



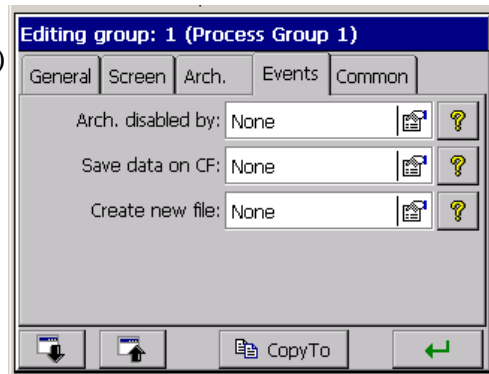


- **Save data on CF:**

The forced storage of the newest group data from the buffer to the CF card follows at the moment of changing the input state of the selected logic channel from 0 (OFF) to 1 (ON) → transition from the negative output value to the positive output value, see the **Note** below.

- **Create new file:**

The forced creation of a new file with group data follows at the moment of changing the logic state of the selected channel, from 0 (OFF) into 1 (ON) → transition from the negative output value to the positive output value, see the **Note** below.



Configuration parameters common for **all logic channel group** programmed in the recorder are set in the **Common** tab:

- **Auto-view delay:**

Time of screen switching enabled by the user in the context menu option (see below)

- **Events:**

- **Archive disabled by:** Lack/Disabling of data archiving follows when the logic state of the selected logic channel is 1 (ON), see the **Note** below

- **Save data on CF:** Lack / Forced storage of the newest measuring data from the buffer on the CF card follows at the moment of changing the state of the selected logic channel from 0 (OFF) to 1 (ON) → transition from the negative output value into positive output value, see the **Note** below:



The analog output value of the logic channel **higher** than zero is interpreted in KD7 as a logic state (ON) of the given channel.



- **Create new files:** Lack/New files with data of measuring groups will be created at the moment of changing the logic state of the selected channel from 0 (OFF) into 1 (ON) → transition from the negative output value into positive output value, see **Note** above.

- **Change group:** Lack/Change displayed group when logic state of the selected channel is 1 (ON), see **Note** above.

- **Change view:** Lack/Change displayed view of a group when logic state of the selected channel is 1 (ON), see **Note** above.

- **Output time from the archive:** The set time of automatic output from archive data review (see section 8.8.) , in case when the user forgot to close it. The time is counted from the last pressure of the button in the context menu.

- **File format:** Selection of the format which measuring data on the CF card will be stored in, CSV with the digital signature or CSV without the digital signature ( see section 8.3)



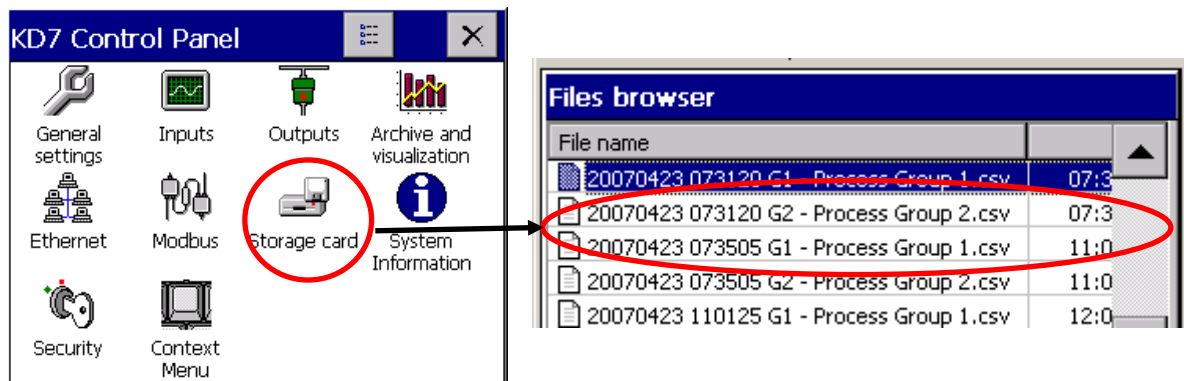
- **Audit log:** When it is set as **Enabled** it is displayed on the screen (see section 7.11) and saved on the CF card. When it is set as **Disabled** it is displayed on the screen, but it is not saved on the CF card.

Parameters in the **Common** tab can be modified from the level of each other measuring group.

Each from 4 channel groups can be disabled. Measuring data from particular groups are stored in the CF memory card of 8 MB capacity, in the format \*.csv or binary ( see section 8.3.)

The text file in format \*.csv is serviced by the Excel program, and the binary file can be reviewed in the KD Archive program (see section 9.4).

Structure of the channel group file stored in CF card, with measuring data:



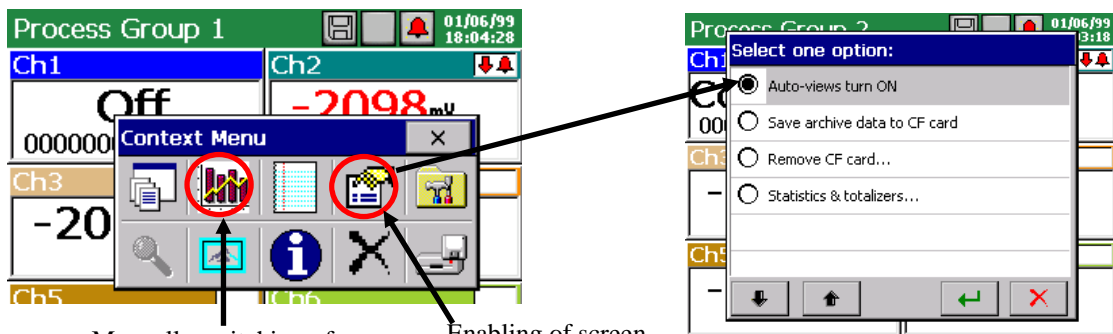
File name	
20070423 073120 G1 - Process Group 1.csv	07:3
20070423 073120 G2 - Process Group 2.csv	07:3
20070423 073505 G1 - Process Group 1.csv	11:0

Year, Month, Day

Hour, Minute, Second, Group symbol

File name

During the display of measuring data, one can switch screen views manually through successive pressures of the view icon in the **Context Menu**. One can also in the option window enable the previously (see above) programmed automatic cycle of their switching.

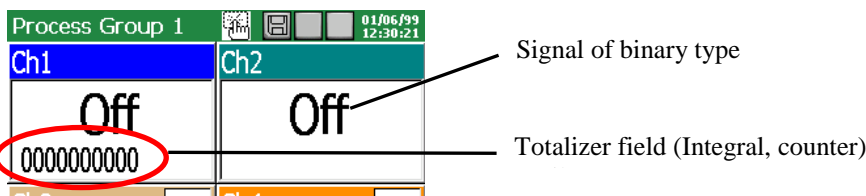
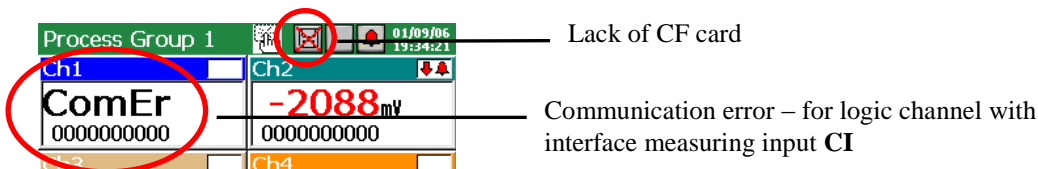
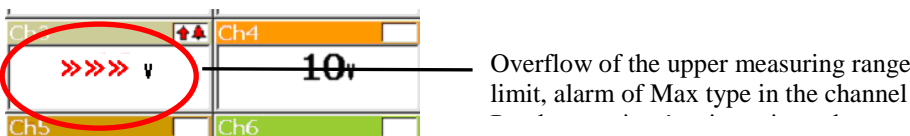
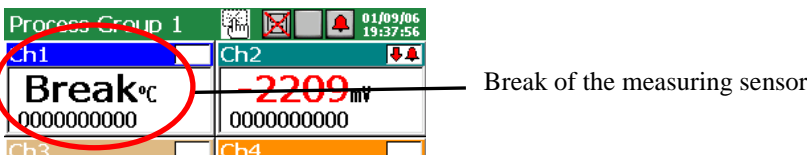
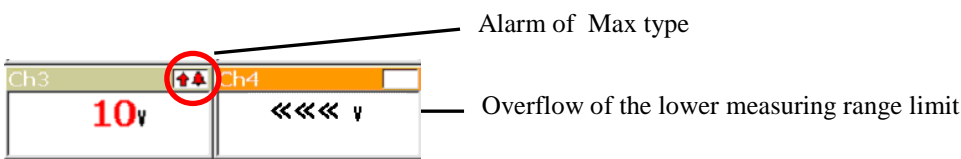
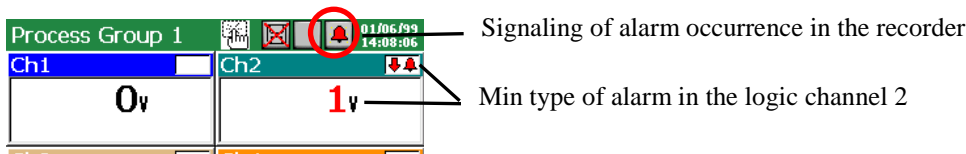


Manually switching of screens

Enabling of screen automatic switching

Information about the current recorder operation state are displayed on recorder screens, actual measurement value, alarm information, range overflows, sensor breaks, communication errors (interface inputs), lack of data, and on statistics and bargraph screens, information about minimal and maximal measurement values in the current session period of the recorder operation.

### 8.2.2. Digital view of channel group.



The type and the alarm value, in the given logic channel, can be read out in the **KD7 Control Panel**, in the menu of the **Input** icon.

### 8.2.3 Linear chart of the channel group

The chart orientation (horizontal or vertical), the thickness of the signal line and the screen background (black or white) are selected in the edition menu of the logic channel group.

#### - Horizontal chart:

Alarm in the logic channel

Sensor break

After pressing on the field of the selected channel, the description of the analog scale is switched on the programmed output range in this channel.

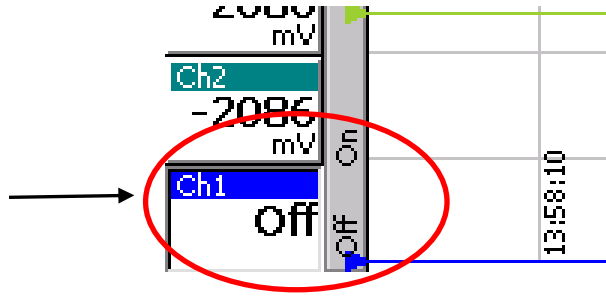
The entry to the option **Servicing of archive data** (see p. 8.8) is accessible during the display of the screen with the linear chart (horizontal or vertical). When browsing archive data, the icon informing about the operation in this mode is displayed on the screen.

Recorder in the review mode of archived data

To change the screen view from horizontal into vertical (concerns the linear screen and bargraph), one must choose the vertical chart orientation in the **KD7 Control Panel – Visualization and archiving** (see p. 8.2.1), in the **Screen** tab.

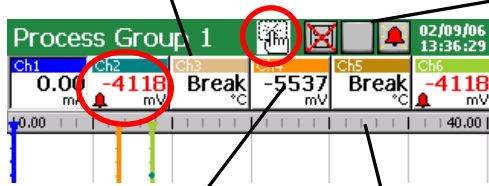
For the linear chart (horizontal and vertical) one can select the view background and thickness of the chart line.

Binary type of the signal.  
 After pressing the field of the selected channel, the scale description is switched on the programmed output range 1 (ON) / 0 (OFF) of the given channel



**- Vertical chart:**

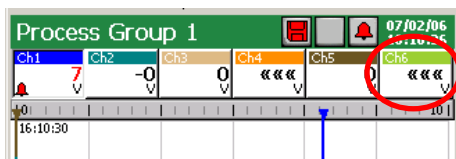
Alarm in the channel



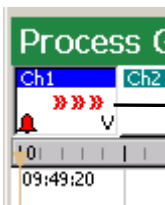
Information about the possibility to open the context menu through a finger pressure on the screen.

Sensor break

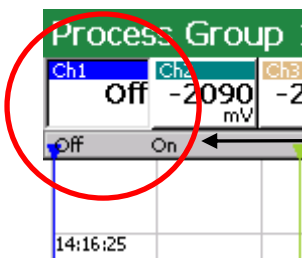
View of the output range scale for the 4 th. logic channel (switching of the scale follows after pressing the field of the selected measuring channel).



Overflow of the lower limit of the measuring range in the 6 th logic channel.



Overflow of the upper limit of the measuring range, alarm in the channel.



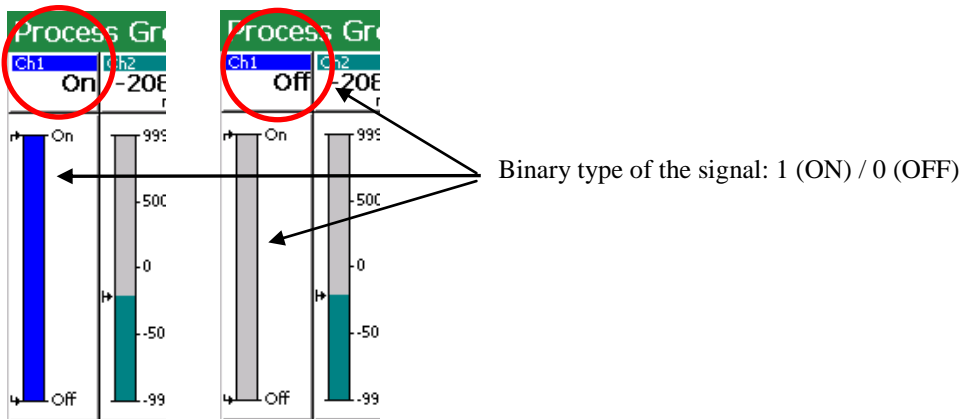
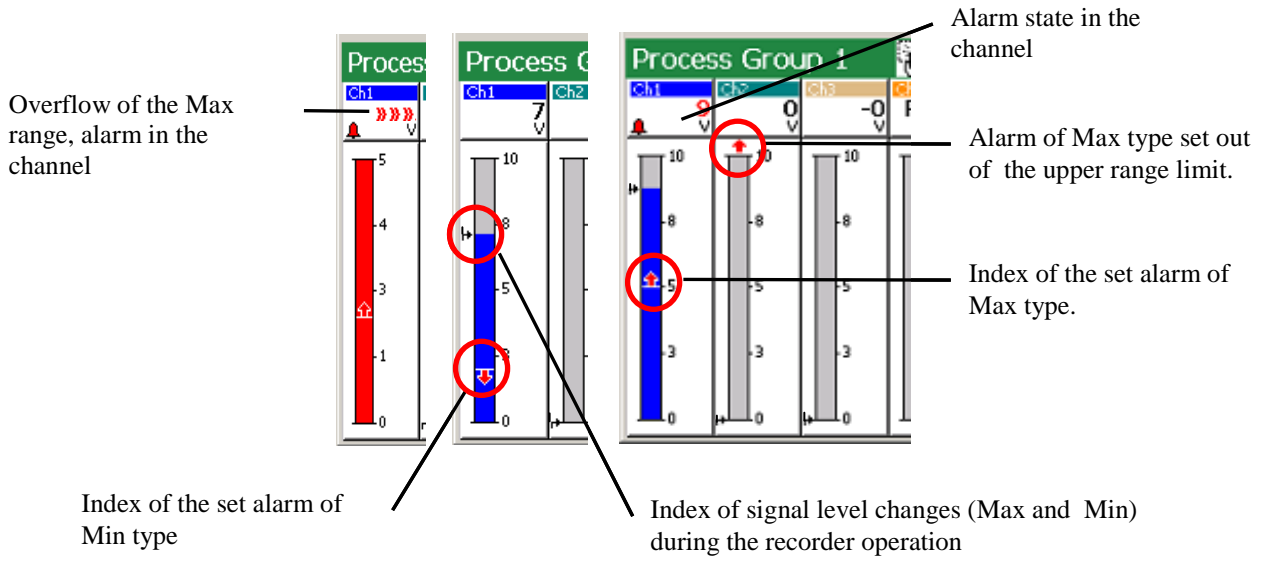
Binary type of signal.  
 After pressing on the field of the selected channel, the scale description is switched on the programmed output range 1 (ON) / 0 (OFF) of the given channel.

Settings of the type and alarm value in the selected logic channel can be read out in the **KD7 Control Panel channel**, in the **Output** icon menu, **Alarm** tab.

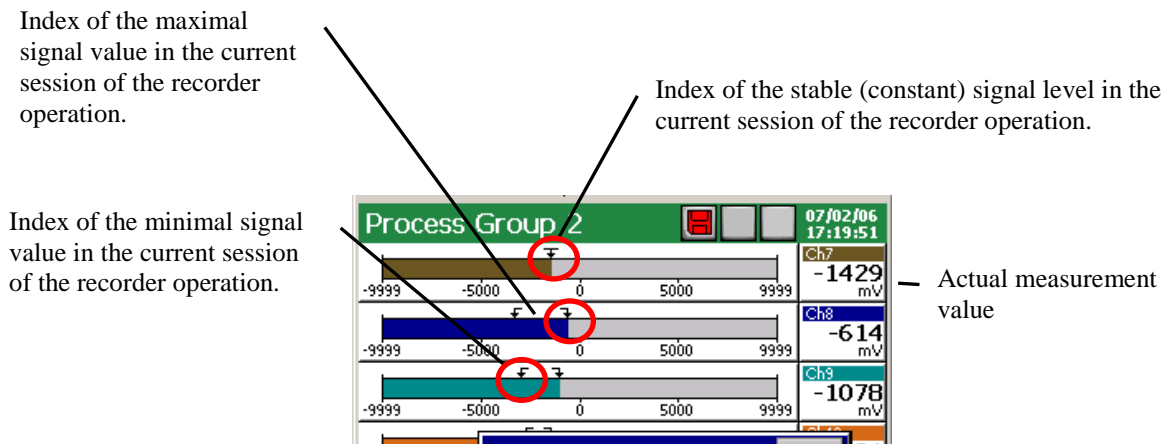
Totalizer data are not displayed on linear screens of the channel group.

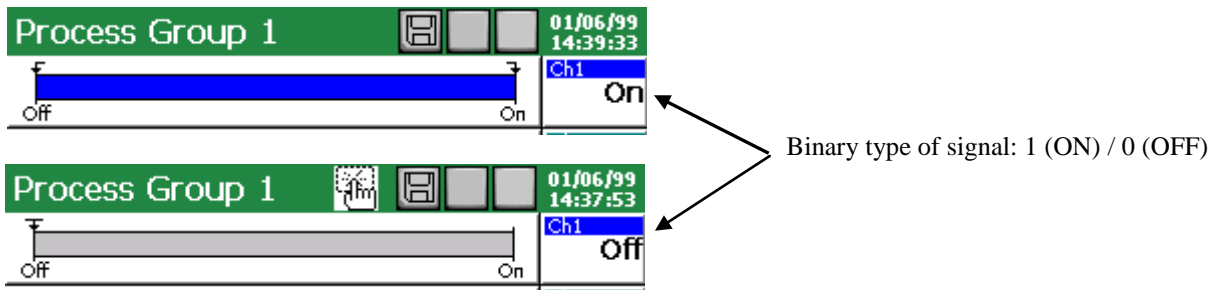
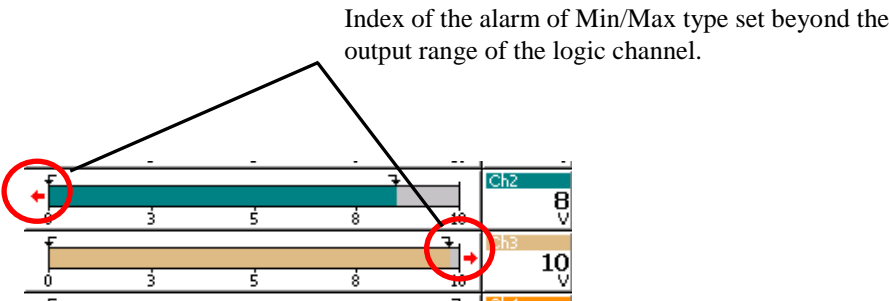
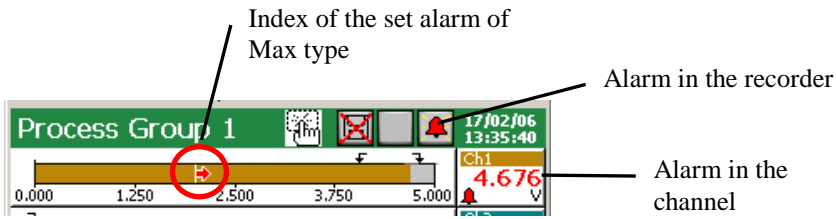
## 8.2.4 View of the channel group in the form of bargraphs

### - Vertical:

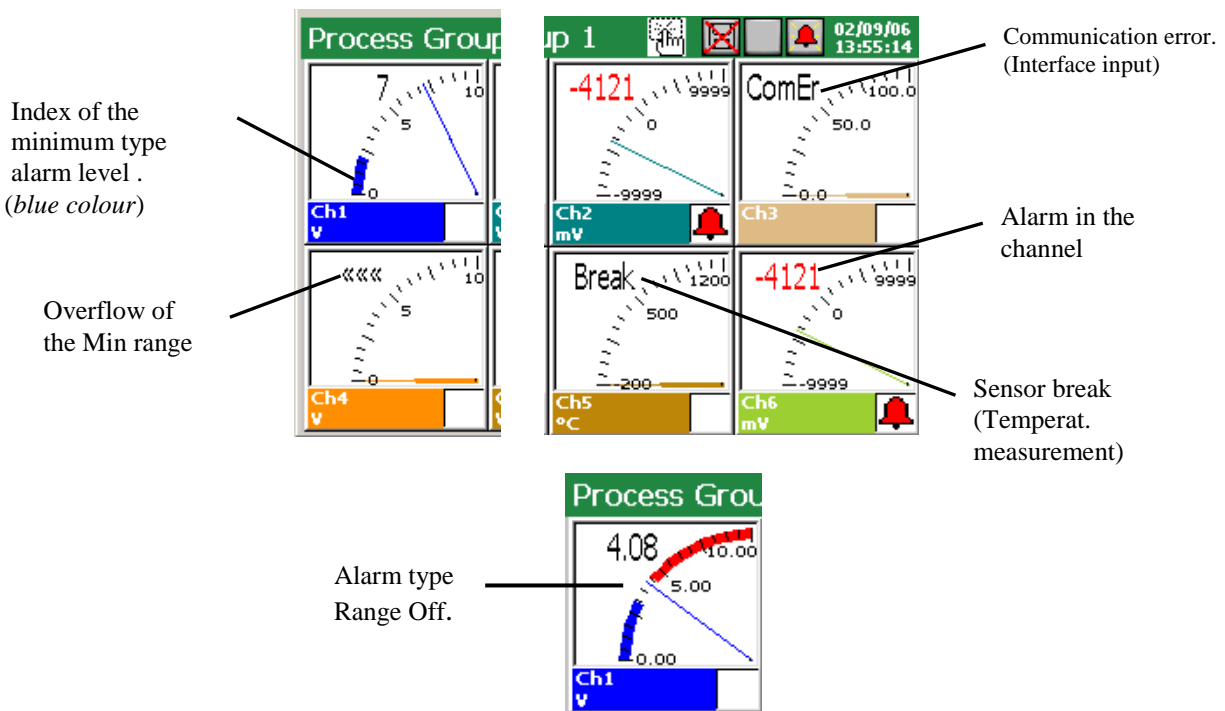


### - Horizontal:



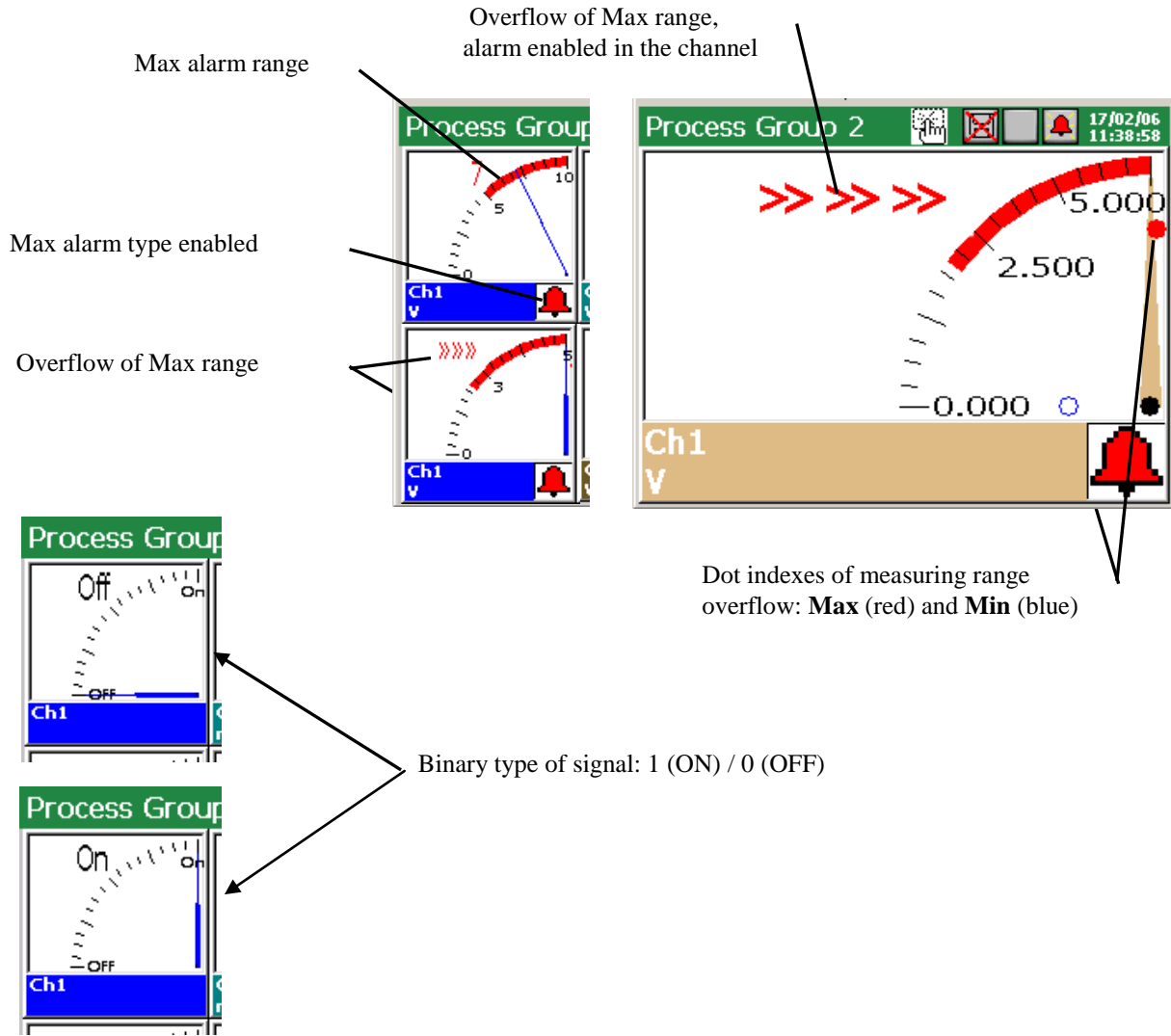


### 8.2.5 Analog view of the channel group

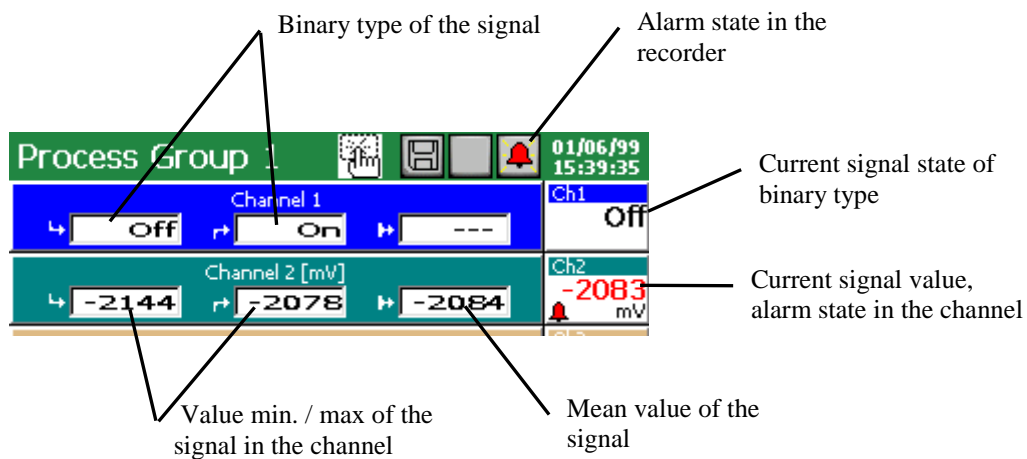


The set area of the Min type alarm is marked in blue colour on the analog indicator.

The set area of the Max type alarm is marked in red color on the analog indicator.



### 8.2.6 Statistic view of channel group

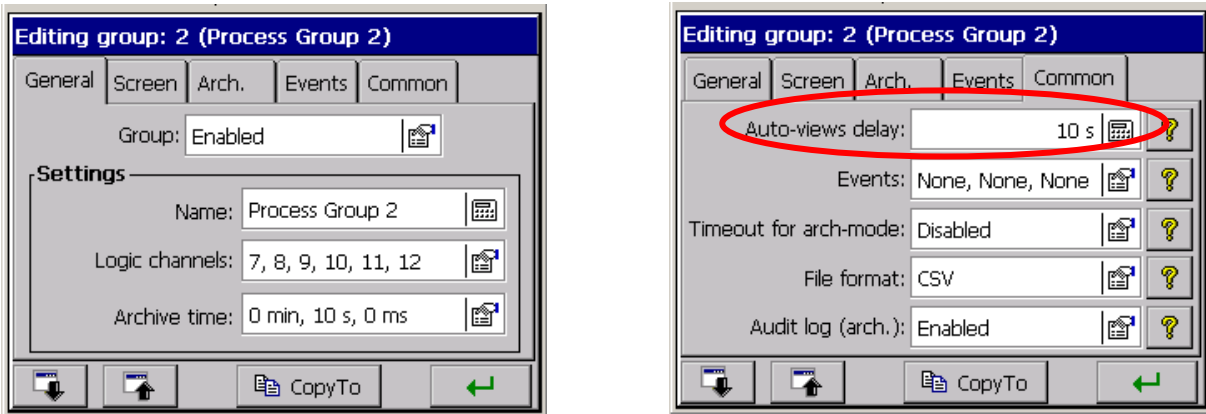


On the statistic screen following values are displayed: minimal and maximal values of the measured signal in the current session period of the recorder operation, mean values, current signal value, is signaled and the messages about the range overflow, sensor break, current alarm state, messages about the range overflow and sensor breaks, the alarm state in the recorder and the given measuring channel is also signaled.

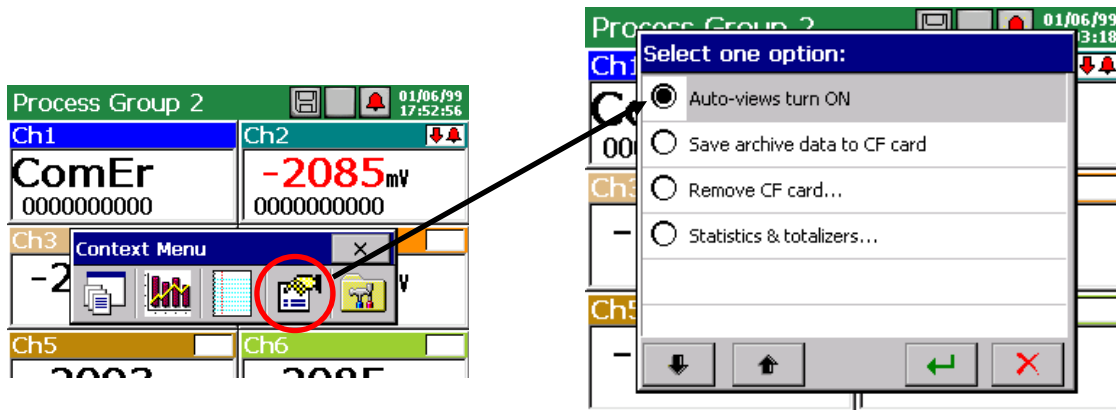
### 8.2.7 Enabling/disabling the screen switching in the group

During the recorder operation, types of screens programmed in the **KD7 Control Panel** → **Visualization and Archiving** → **Edited group** → **General** menu, for currently selected group of channels for presentation, are displayed.

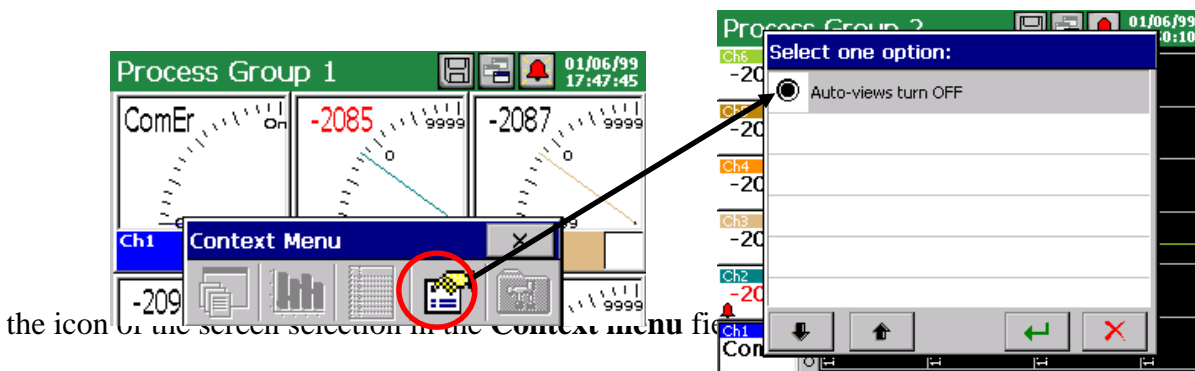
After programming in the edition group window, in the **Common** tab, the time of changing the screen views (the screen is common for all measuring groups), one can enable or disable during the visualization, the option of automatic screen switching without the necessity to enter into the **KD7 Control Panel**.



To enable the automatic switching of screens, one must mark and accept the **Auto-views turn on** function in the selection window of the **Context menu** option.

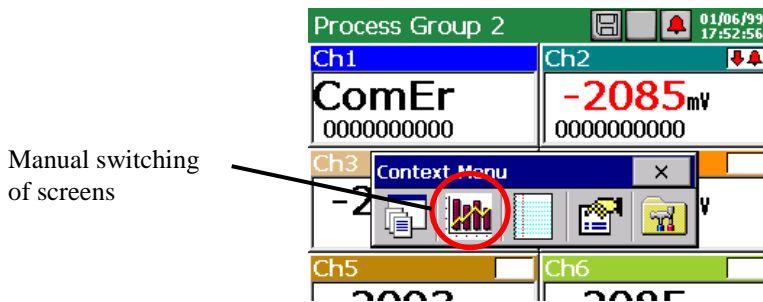


To enable the automatic switching of screens, one must mark and accept the **Auto-views turn on** function in the selection window of the **Context menu** option.



the icon of the screen selection in the context menu file

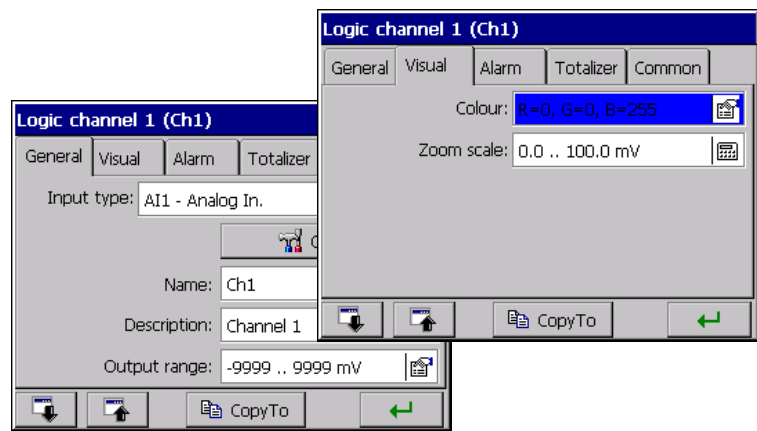




Manual switching of screens

### 8.2.8 Zoom scale function of the signal (measuring magnifier)

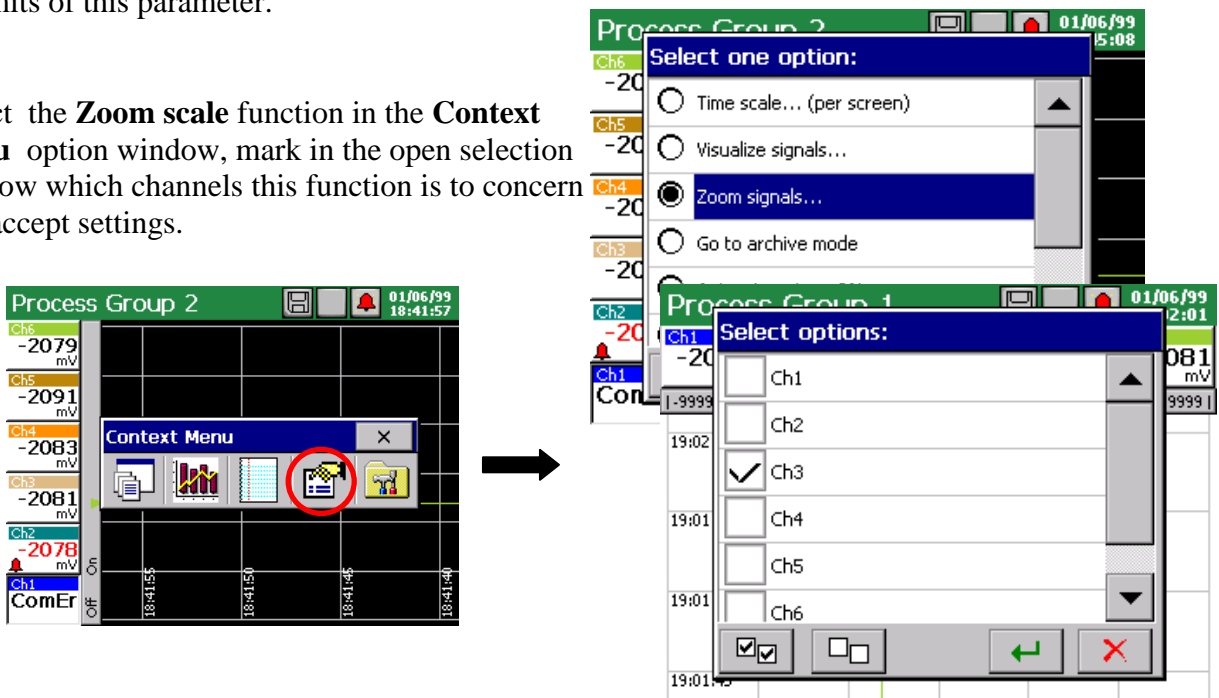
The **Zoom scale** function of signals concerns and is accessible only during the display of a linear screen. The activation of this function causes the display switching of the selected logic channel in output range limits, into the display in limits of the set range by the parameter **Zoom scale** (see section. 8.2.8).



... **KD7 Control Panel** → **Inputs:**

After programming the **Zoom scale function**, one can enable the display of the measurement result in limits of this parameter.

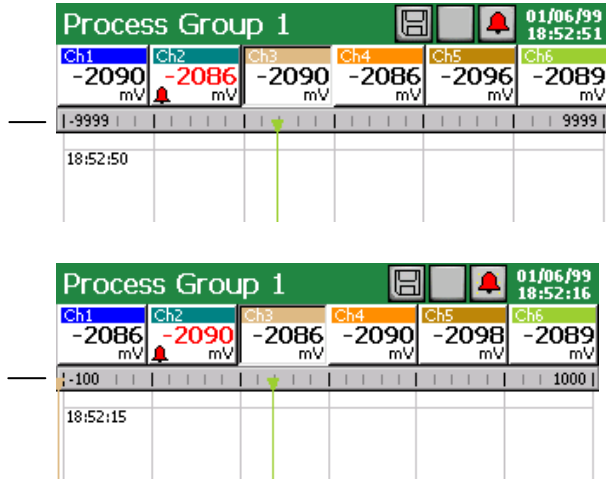
Select the **Zoom scale** function in the **Context menu** option window, mark in the open selection window which channels this function is to concern and accept settings.



Output range of the 3 th logic channel

The display switching of the measurement result of selected channels follows on the view in limits defined by the parameter **Zoom scale (Logic channel (n) → Visual)**

3 th logic channel , Zoom scale is enabled



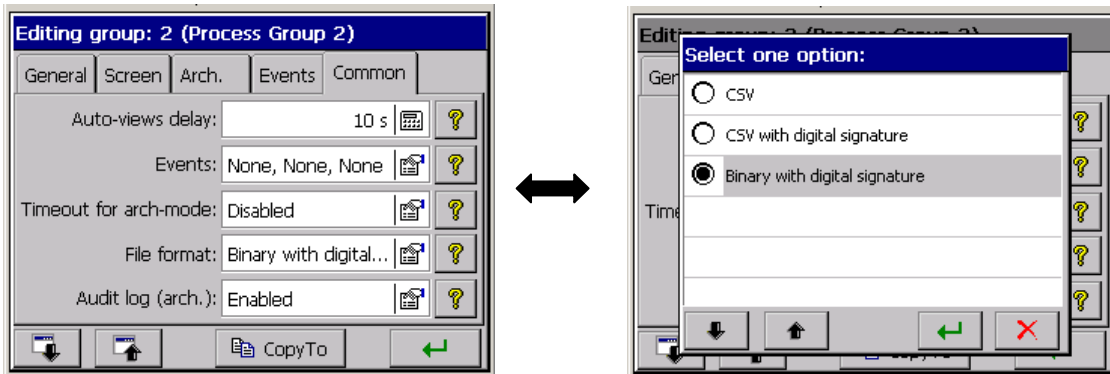
To enable the **Zoom scale** function, one must in the option window of the **Context menu**, during the display of the linear screen, select again the function **Zoom scale** for signals and in the **Select options** window, disable marked previously channels (through tapping the screen by a finger in the given channel field ).

### 8.3 Selection of the measuring data file format (digital signature)

One can select the **CSV** data format or **CSV with digital signature** in the **Archive and Visualization → Edited group (n) → Common → File format** menu: **CSV**, **CSV with digital signature**, **Binary with digital signature**.

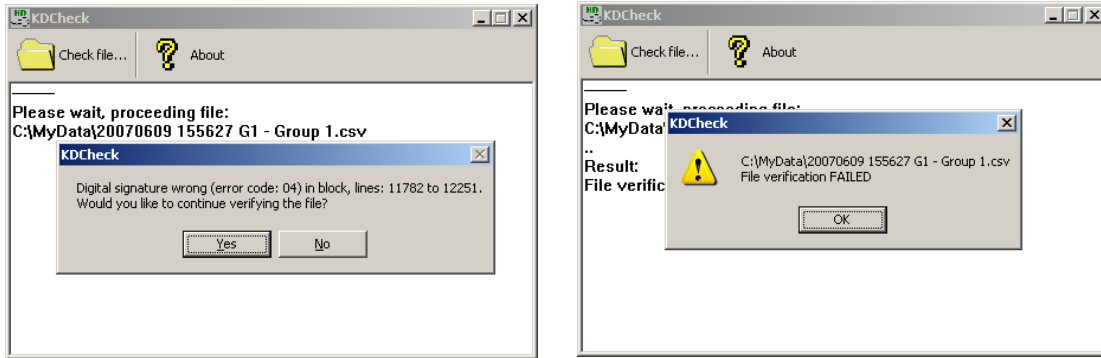


Data stored in binary format can be reviewed only in the **KD Archive** program (see section 9.4).



The digital signature in the „enciphered” information enabling to check the likelihood of stored data in the “CSV with digital signature” or data stored in binary format “ Binary with digital signature”. After selecting the format of file storage „CSV with digital signature” at every defined number of measurement series (data block), a 128 bit „digital signature” is stored in the file. Each, even an incidental change of data will be signaled during the file check by the **KD Check** program (see section 9.3).

**Since the CSV file includes the digital signature at every defined number of measurement series, the file area (range of lines from...to) will be indicated, which includes errors. Remaining data, for which the program does not ascertain data non-conformance with the signature, are credible and can be useful.**

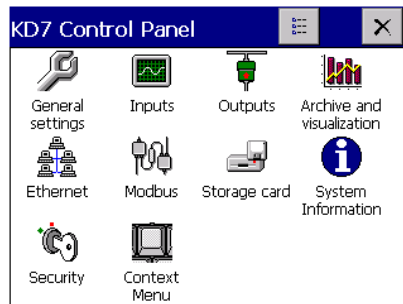


The likelihood (digital signature) of data stored in binary format is automatically checked during the review in the KD Archive program (see section 9.4.).

The program shows the data area in which changes have been made.

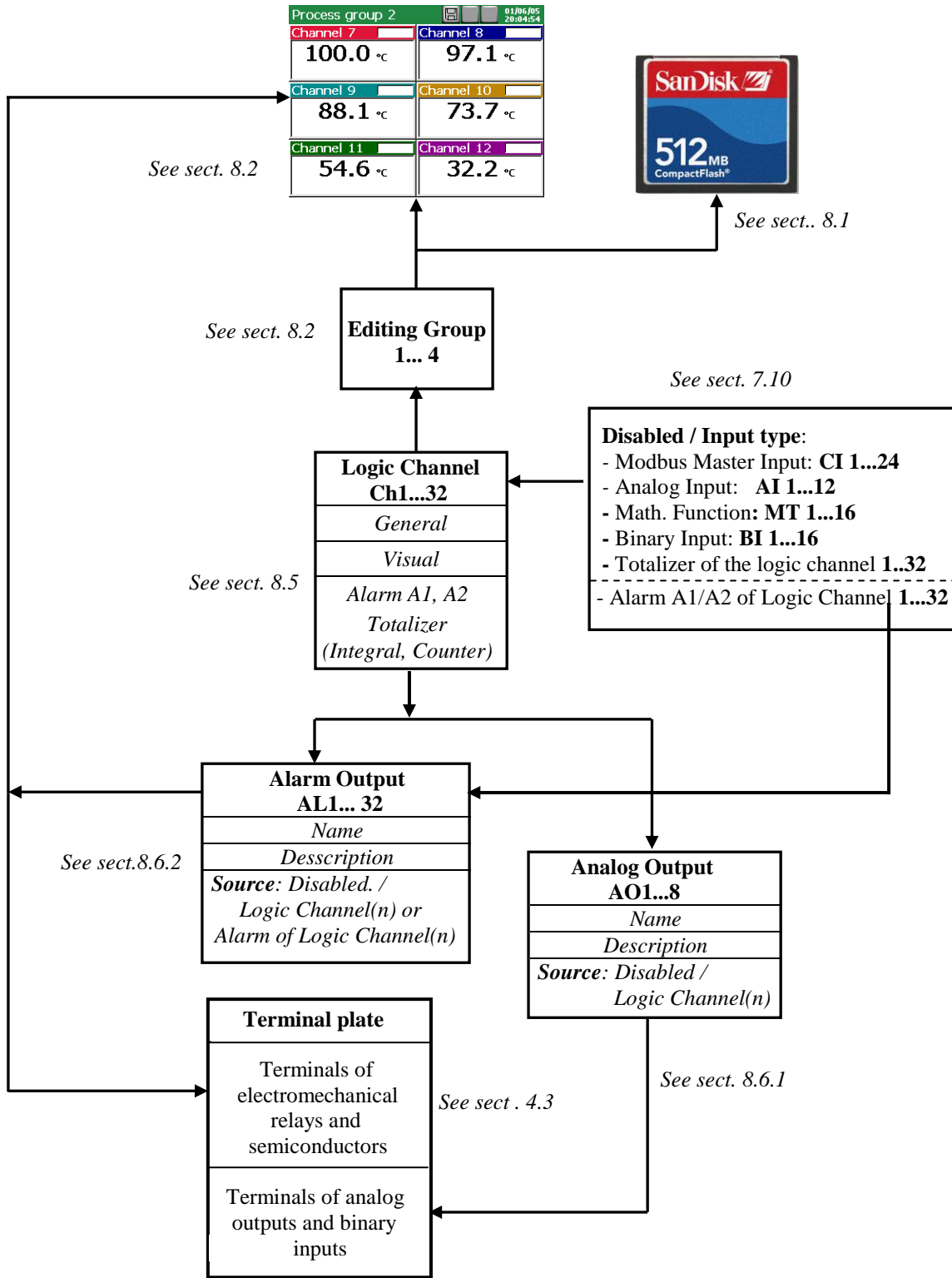
#### 8.4 Structure of the data flow in the KD7 recorder

After selecting **Input** icons in the **KD7 Control Panel** window, the selection and programming the **Logic channel** window is accessible ( programming and explanation of the logic channel notion (see section 7.10)

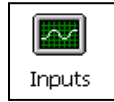


The logic channel is the signal source for the system of alarm outputs, the system of analog outputs, and is the element of the channel group configuration.

Measuring data from each group are displayed on the screen and stored in the CompactFlash memory card.



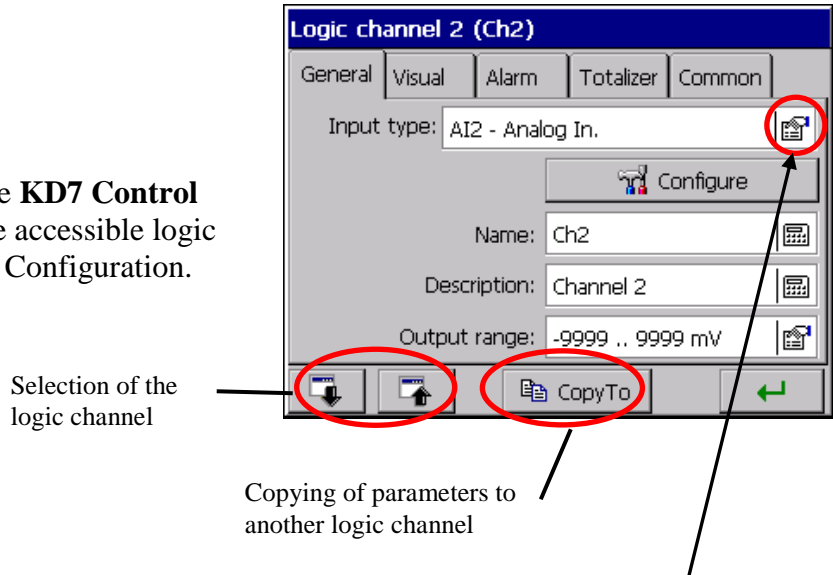
## 8.5 Programming logic channel parameters



After selecting the **Inputs** icon in the **KD7 Control Panel** window, the logic channel edition window is opening

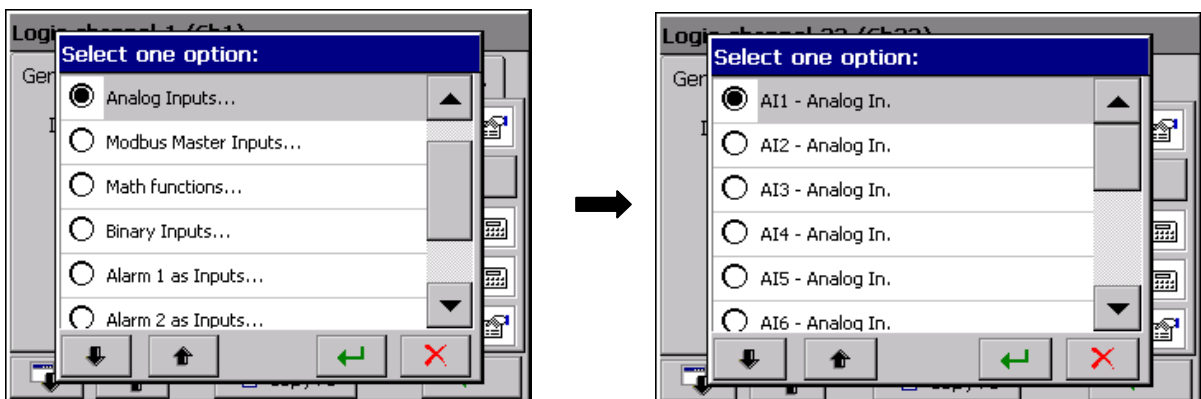
### 8.5.1. Programming General, Visualization and Common parameters

After selecting **Input** icon in the **KD7 Control Panel** window, select one of the accessible logic channels in the **General** tab for Configuration.

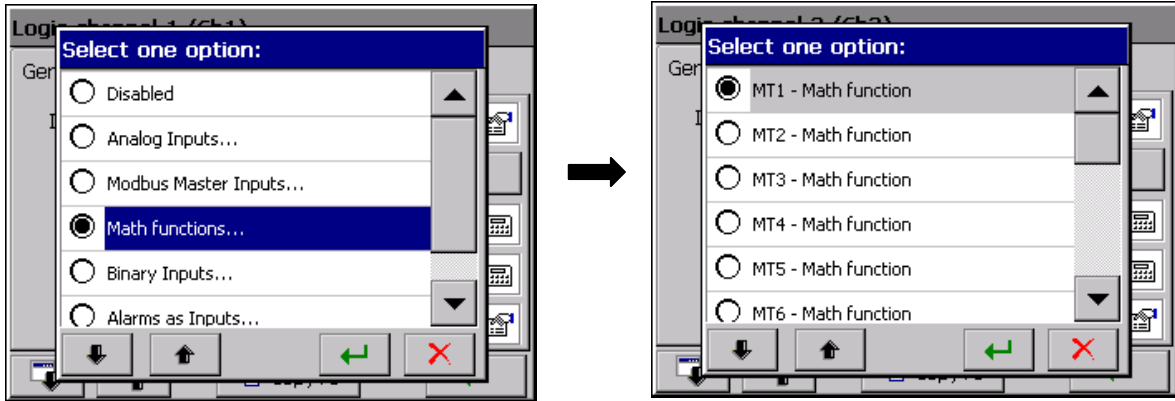


Next, transit to the selection and configuration of the selected measuring input in the given logic channel.

1. When the recorder is arranged in the version without mathematical functions or these functions, are disabled (see. Section 7.10.3.3.), analog measuring inputs **AI 1..12** (see section 7.10.3.2.), interface Modbus Master inputs **CI 1..24** (see section 7.10.3.1.), binary inputs **BI 1..16** (see section 7.10.3.4.), alarms (A1/A2) logic channels 1...32 (see section 7.10.3.5) and totalizers of logic channels 1..32 (see section 7.10.3.6) are available for the configuration.

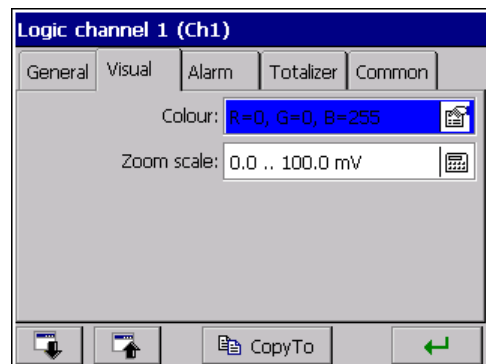


2. When the recorder is arranged in the version with active mathematical functions (see section 7.10.3.3.), analog measuring inputs **AI 1..12** (see section 7.10.3.2.), interface Modbus Master inputs **CI 1..24** (see section 7.10.3.1.), mathematical functions **MT 1...16** (see section 7.10.3.3.), Binary inputs **BI 1...16** (see section 7.10.3.4.), alarms A1/A2 of logic channels 1...32 (see section 7.10.3.5.) and totalizers of logic channels 1..32 are available for the configuration.



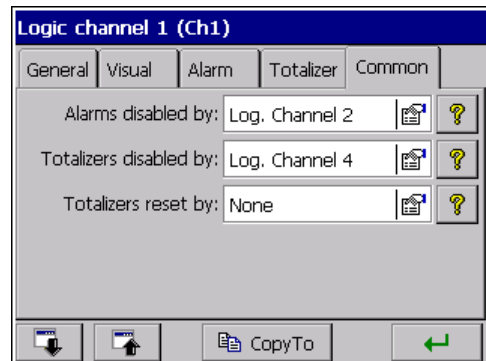
In the **General** tab of the logic channel window, one must write the name and channel description and define its output range (input measuring data are proportionally converted into values in programmed limits of the output range and in output values are stored on the CF card, and displayed on the screen).

In the **Visualization** tab, select the presentation colour of the given logic channel and set limits for the **Zoom scale** function (measuring magnifier) see section 8.2.8.



In the **Common** tab, select logic channels (sources) which the logic state is to control alarm disabling, disabling and totalizer reset.

- Disabling of alarms and totalizers follows when the selected source will be in logic state 1 (ON).
- Reset of totalizers follows at the moment when changing the logic state of the selected source from 0 (OFF) on 1 (ON).



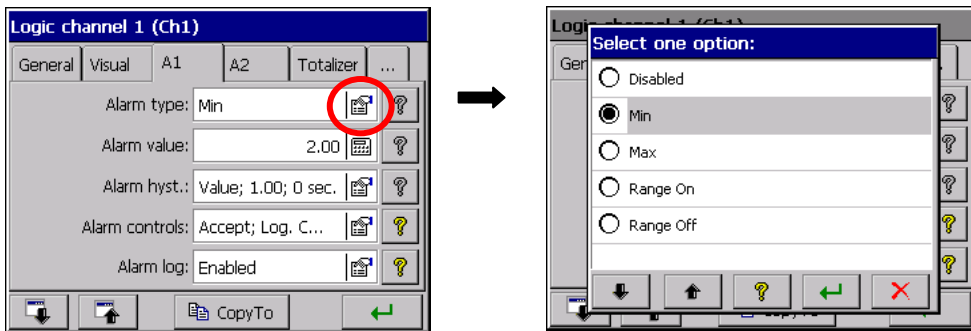
Note: The analog output value of the logic channel higher than zero is interpreted as a logic state 1 (ON) of the given channel.



Parameters set in the **Common** tab in the selected logic channel are set automatically in all remaining logic channels

## 8.5.2 Programming of alarms in logic channels.

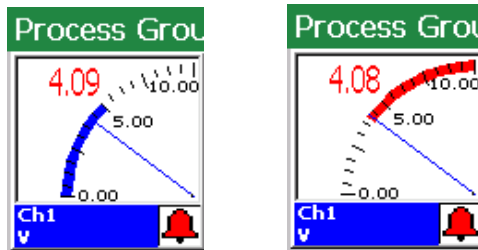
In logic channels, choose and set alarm parameters in tags **A1** and **A2** (settings will be active after the write of the recorder configuration):



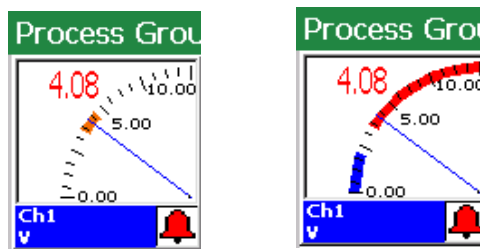
- **Alarm type:**

- **Disabled** or

- **Min, Max** - alarm jest włączony gdy wartość kanału jest poniżej /powyżej/ ustawionej wartości alarmu



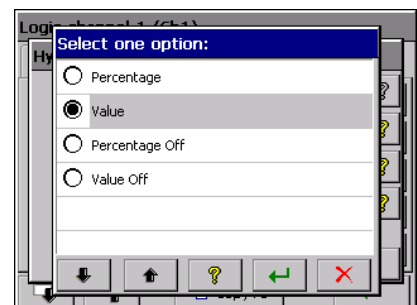
- **Range ON., Range OFF** – The alarm is switched on when the channel value is between/beyond set alarm values (lower limit, upper limit).



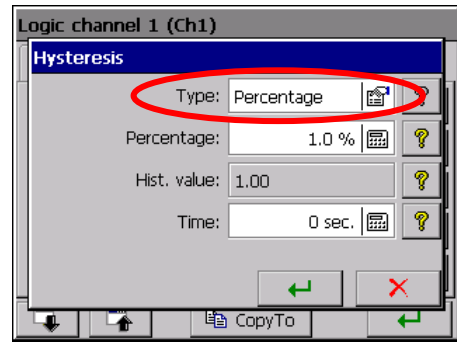
- **On Error** – alarm is activated if any error on input occurs (sensor break, communication error or range exceeding)

- **Alarm hyst.:**

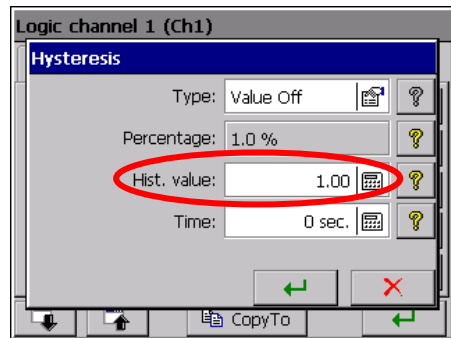
- **Type** - Percentage, Value, Percentage Off., Value Off. (influence the state of the alarm switching on and off).



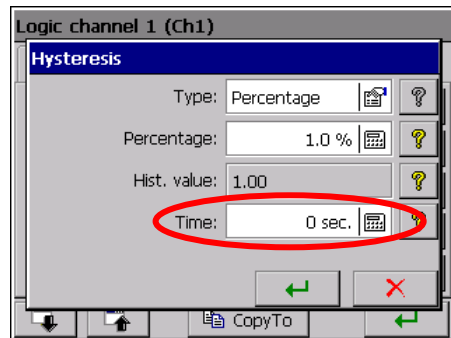
- **Percentage**  
(for type Percentage and Percentage Off)  
– *edition of values in percentage of the channel range.*



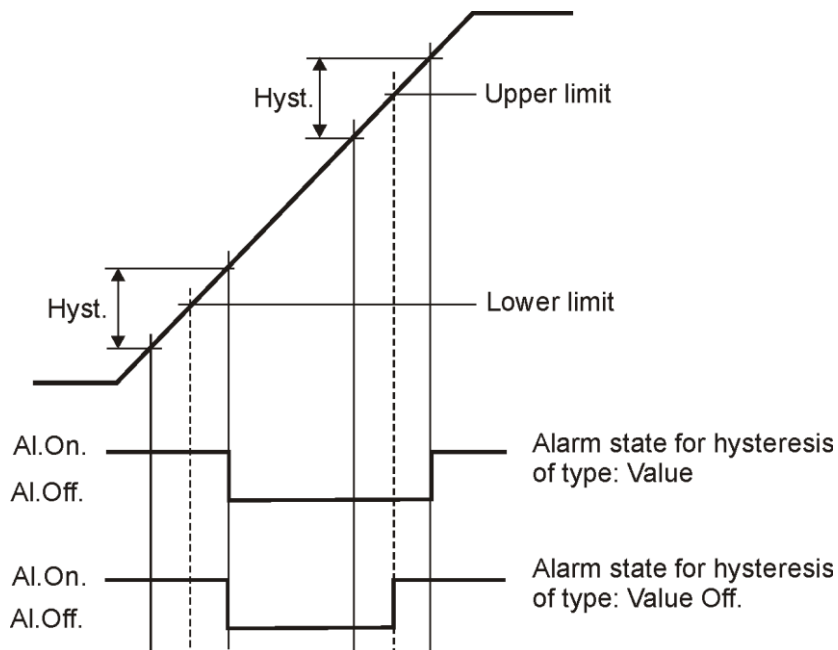
- **Hyst. value**  
(for type Value and Value Off)  
– *edition of values in channel range units (positive values)*



- **Time**  
(hysteresis value in time units)  
– *edition of values*

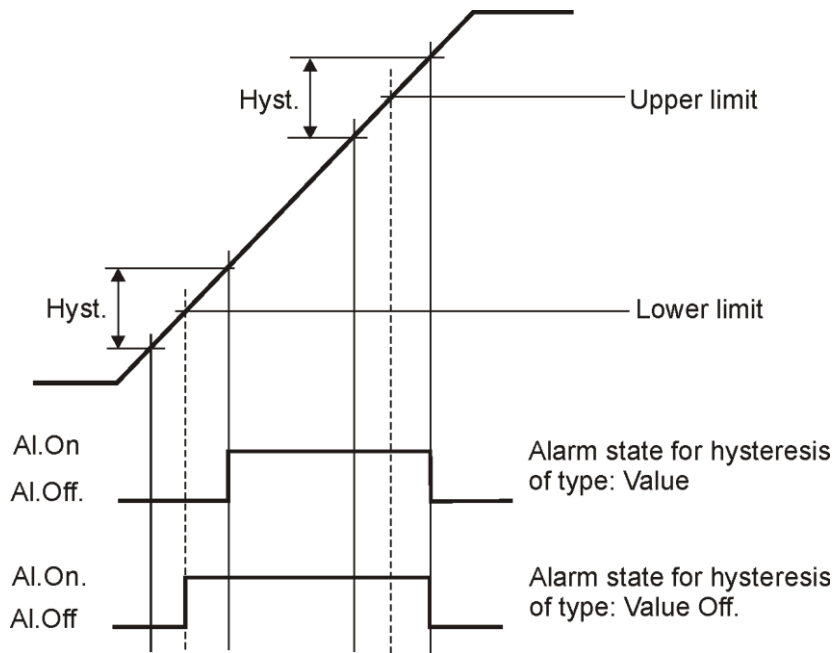


After programming the alarm hysteresis, valuable or in percentage, and temporary higher than zero, the action of the alarm follows when both conditions are fulfilled simultaneously.

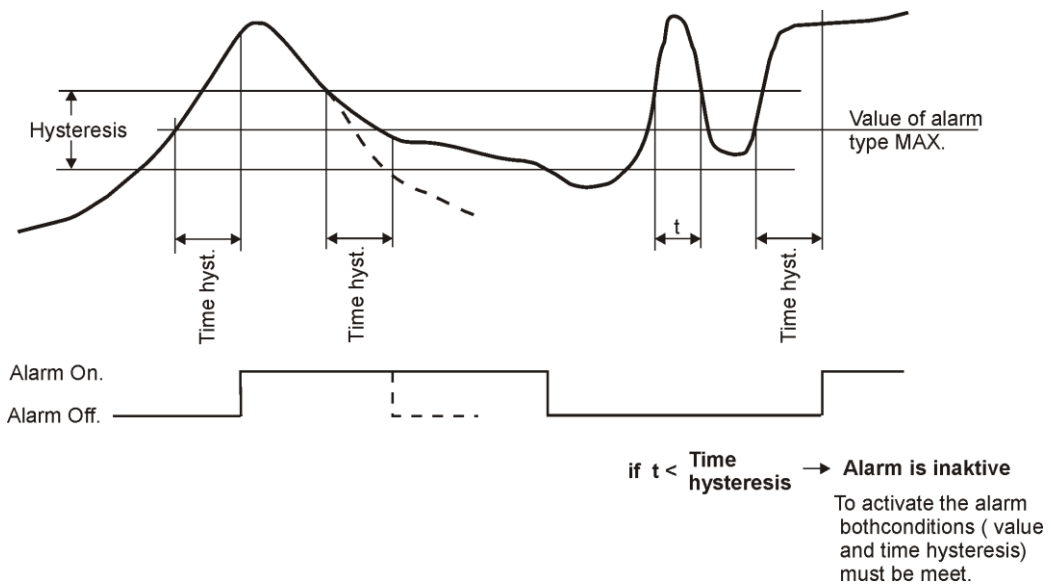


**Fig. 1** Functional diagram of the **value Off** alarm type.



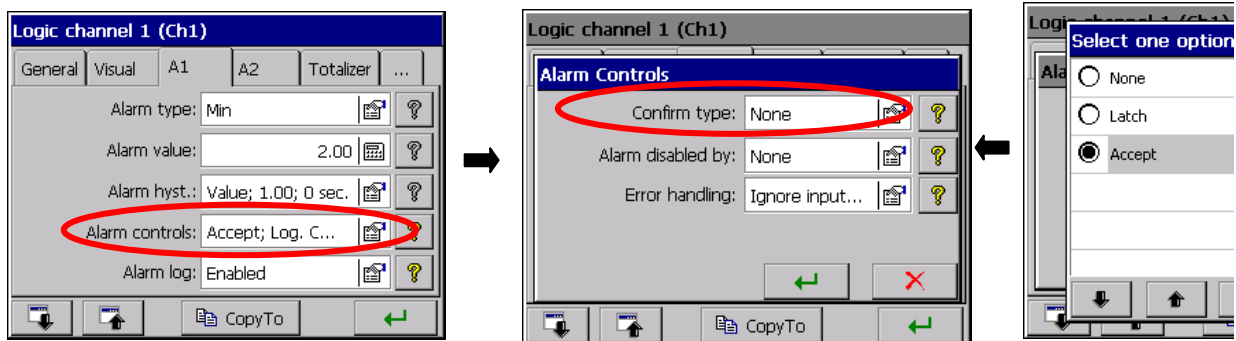


**Fig. 2** Functional diagram of the **Value On** alarm type.



**Fig. 3** Functional diagram of the **MAX** alarm type taking in consideration the hysteresis of **Value** and **Time** type

• **Alarm controls:**



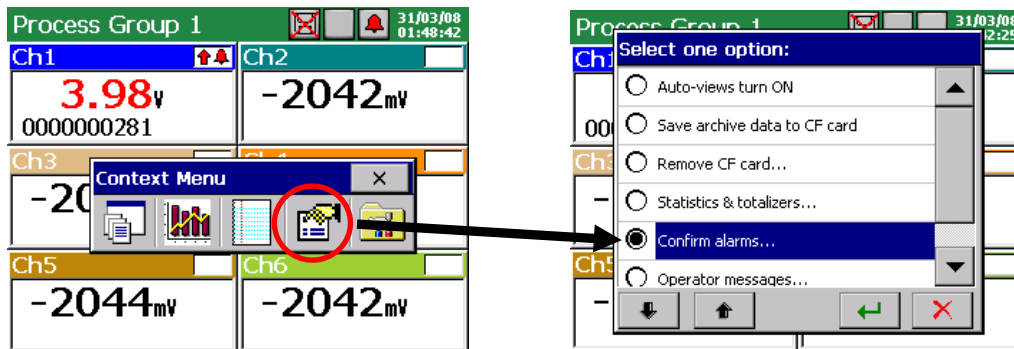
- **Confirm type:**

**None** – option disabled

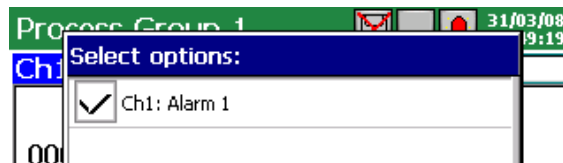
**Latch** – the alarm state is supported in the recorder till it will not be confirmed by the operator.

**Accept** – switching off the alarm state in the recorder by the operator.

During the recorder operation, one can choose in the context menu, the option of alarm confirmation acc. to programmed settings above.



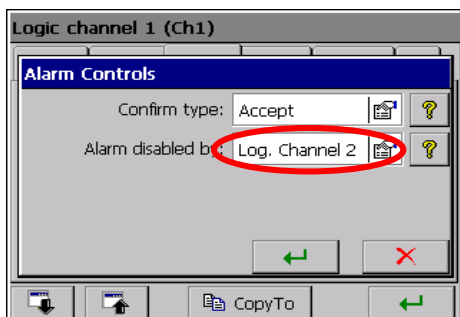
The input in the alarm confirmation menu is protected by the user's password.



- **Alarm disabled by:**

**None** – option disabled

**Logic channels <n>** – Selection of the logic channel which the logic state 1 (ON) will block the current alarm state.

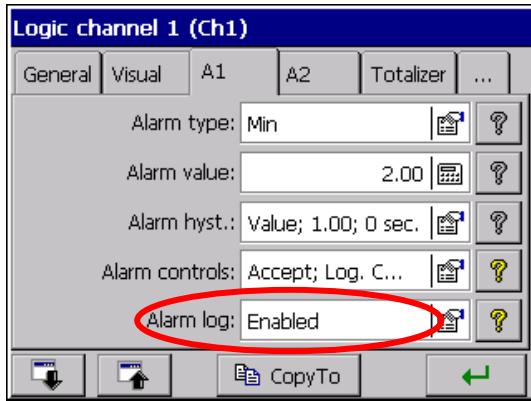


Analog output value of the logic channel **higher** than zero is interpreted as the logic state 1 (ON) of the given channel



- **Error handling:** Ignore input errors, Alarm ON/OFF if input error occurs. Error situations are: communication break and sensor error. A range exceeding is not such event.

- **storage in the log**

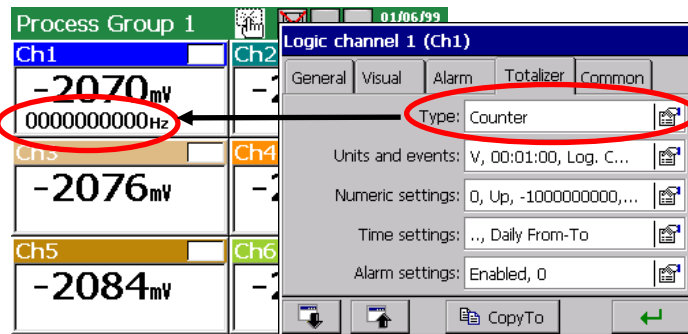


**Disabled / Enabled** – storage of alarm messages in **Alarm log**.

### 8.5.3. Programming Totalizer parameters (Counter/Integral)

Choose the type of programmed function in the **Totalizer** tab ( see section 8.3): **Disabled, Integral** or **Counter**

▪ After selecting the type: **Counter**, one must set following groups of parameters:

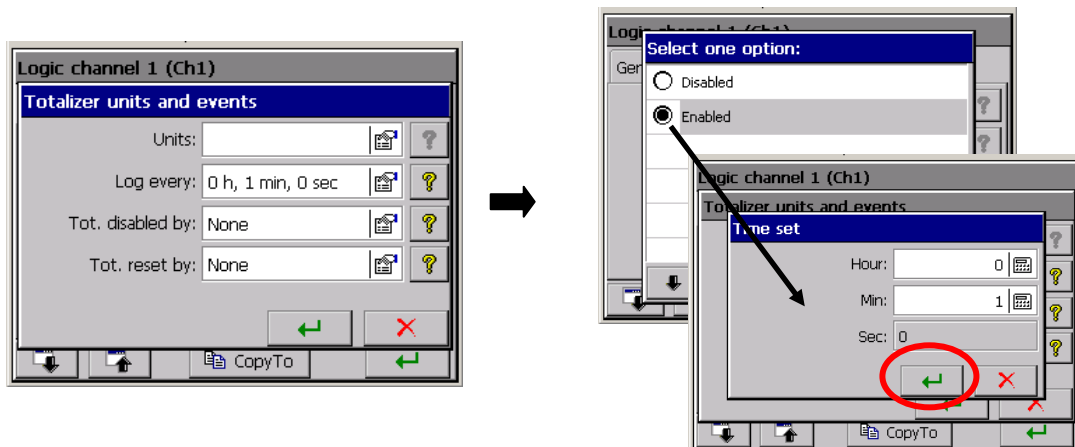


- Unit and events
- Numeric settings
- Time settings
- Alarm settings

→ **In the window of parameters group “Totalizer units and events” following parameters are programmed:**

**Unit:** select defined units or program the own unit.

**Record to the log:** after selecting the “**Enabled**” option set the frequency of the totalizer (counter) data saving to the **Statistic log** (see section 7.11)



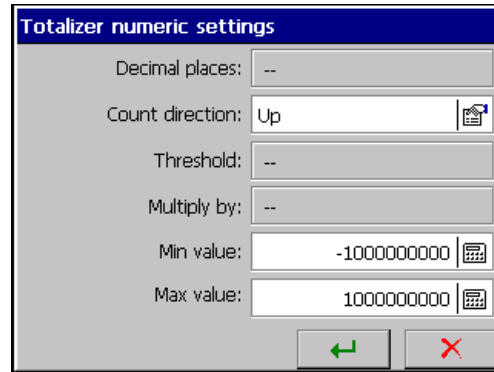
**Totalizer disabled by:** select the logic channel which the logic state 1 (ON) disables the totalizer action (the state in the disabling moment will be preserved).

**Totalizer reset by:** select the logic channel in which the change of the logic state from 0 (OFF) to 1 (ON) will cause the setting of the totalizer state on its value minimally programmed (see numeric settings) and the count restart.

→ In the window of parameters „Totalizer numeric settings” following parameters are programmed:

**Count direction:** Addition/Subtraction

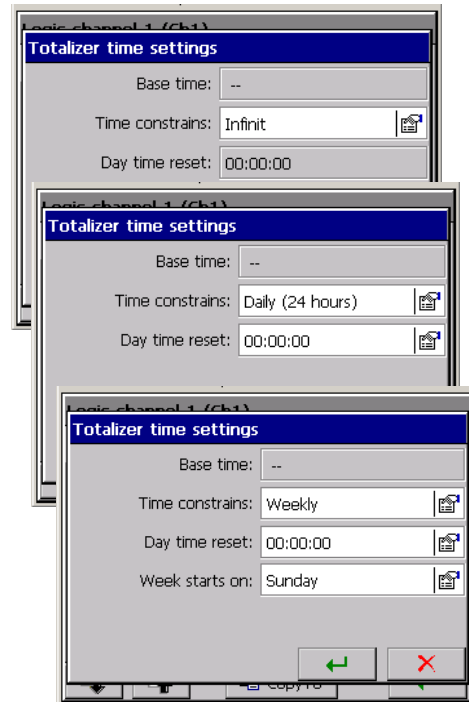
**Min./Max value:** edition of the parameter  $\pm 1000000000$



→ In the window of parameters “Totalizer time settings” following parameters are programmed:

**Count type:** Continuous, Daily (24 hours), Daily (From – To), Weekly, Monthly

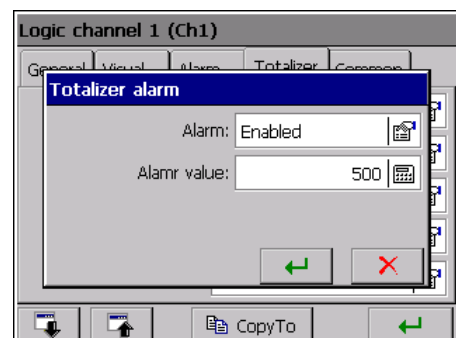
**Day time reset at hour:** not concerns the count type, Continuous and Daily (From – To)



→ In the window of parameters “Totalizer alarm” following parameters are programmed:

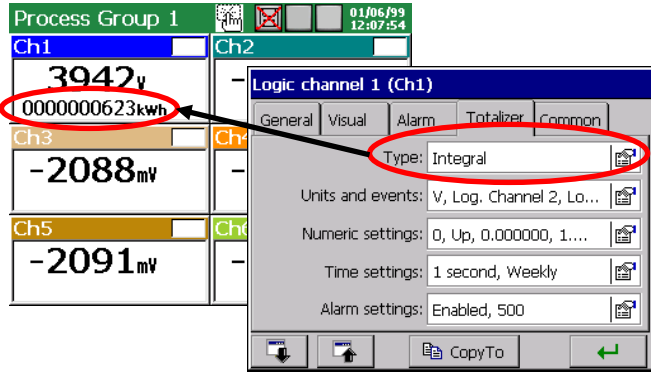
**Alarm:** Disabled/enabled

**Alarm value:** parameter edition



- When choosing the type: Integral, one must set following groups of parameters:

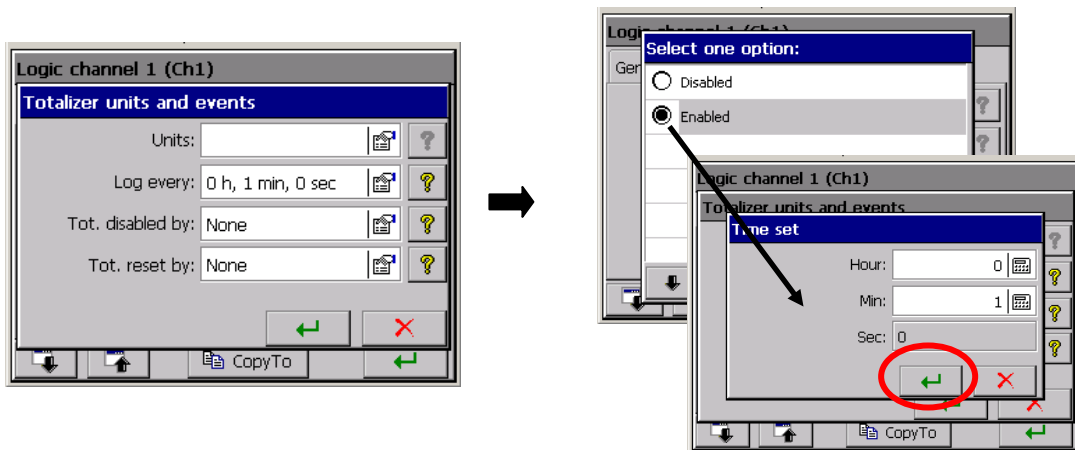
- Unit and events
- Numeric settings
- Time settings
- Alarm settings



→ In the window of parameters “Totalizer units and events” following parameters are programmed:

**Unit:** select defined units or program the own unit.

**Record to the log:** after selecting the “Enabled” option set the frequency of the totalizer (integral) data saving to the **Statistic log** (see section 7.11)

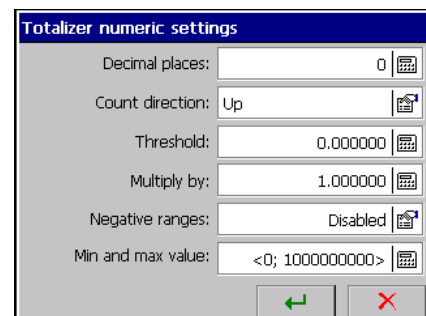


**Totalizer disabled by:** select the logic channel which the logic state 1 (ON) disables the totalizer action ( the state in the disabling moment will be preserved).

**Totalizer reset by:** select the logic channel in which the change of the logic state from 0 (OFF) to 1 (ON) will cause the setting of the totalizer state on its value minimally programmed (see numeric settings) and the count restart.

→ In the window of parameters “Totalizer numeric settings” following parameters are programmed:

- Decimal point:** Edition of the parameter 0...4
- Count direction:** Addition/Subtraction
- Min./Max value:** edition of the parameter  $\pm 1000000000$
- Threshold:** edition of the parameter 0...10000
- Multiply by:** edition of the parameter 0...1000000000
- Negative ranges:** counting below zero ranges
- Min./Max. value:** edition of the parameter  $\pm 1000000000$



→ In the window of parameters “Totalizer time settings” following parameters are programmed:

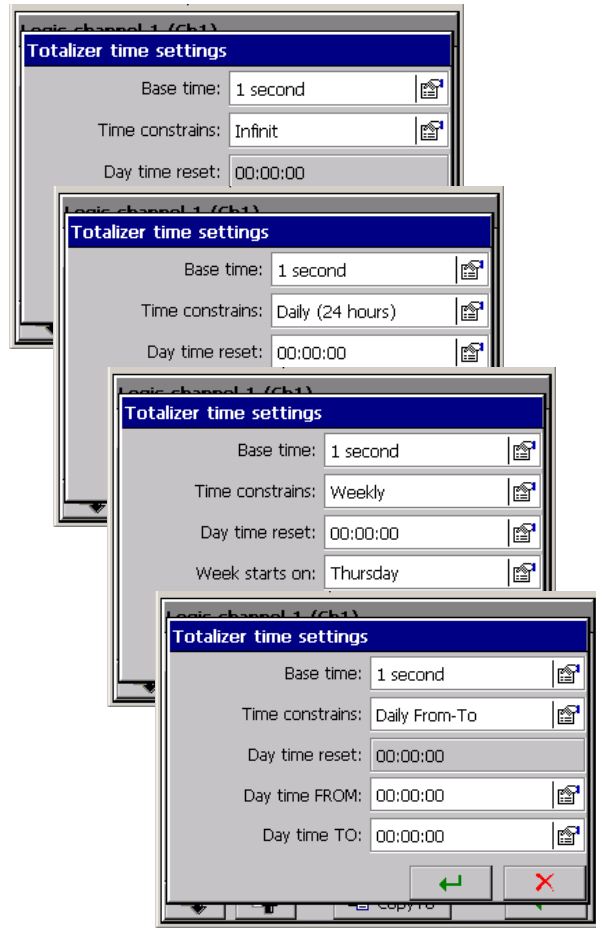
**Base time:** 1 sec, 1 min, 1 hour, 1 day

**Time constrains:** Continuous, Daily (24 hours),  
Daily (From – To), Weekly,  
Monthly

**Dayly time reset at hour:**  
edition of the parameter Hour/min/sec,  
concerns the count type:  
Daily (24 hours), Weekly, Monthly.

**Beginning of the week:**  
concerns the weekly count type

**Daily time from/To:**  
concerns the daily count type (From – To)



→ In the window of parameters group “Totalizer alarm” following parameters are programmed:

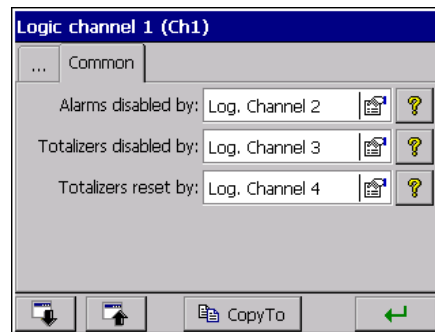
**Alarm:** Disabled/Enabled

**Alarm value:** parameter edition



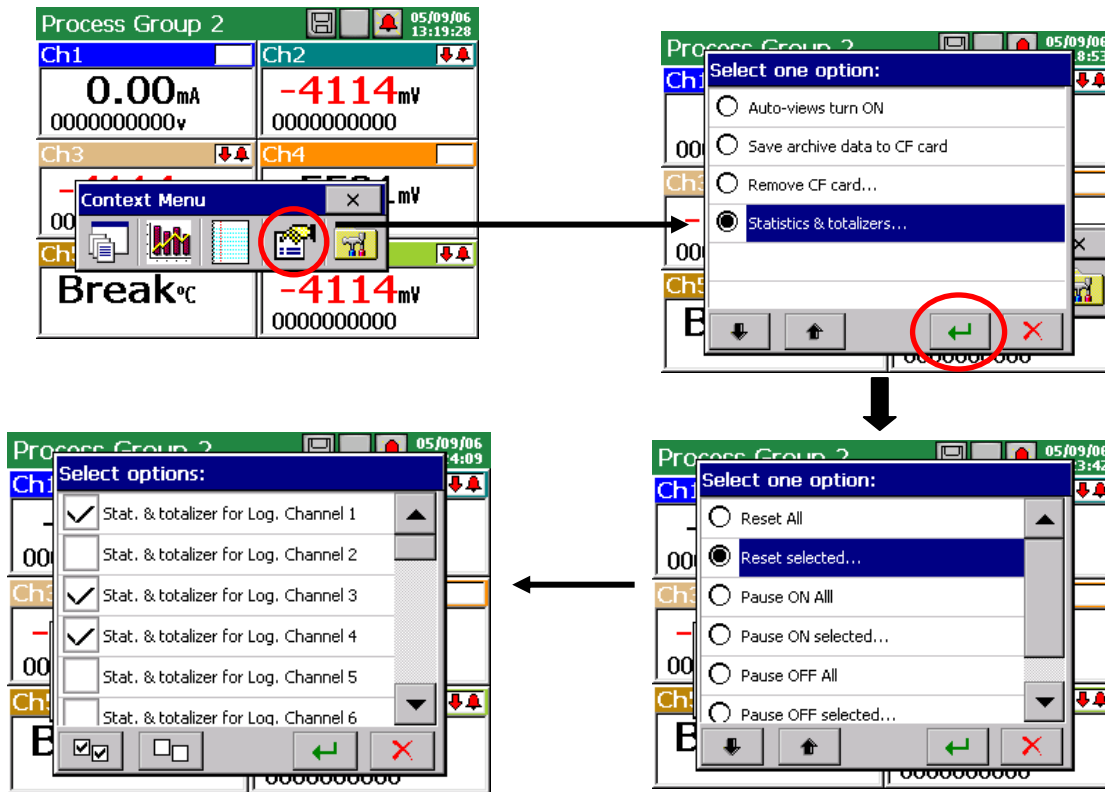
### 8.5.4 Programming of parameters: Common

One can choose in the **Common** tab the signal source (Logic channel 1..32) which the logic state 1 will disable active alarms and/or stop the totalizer operation or reset their current state.



### 8.5.5 Totalizer control (Counter/Integral)

After the previously programming of the **Totalizers** function (**Integral** or **Counter**), one can control them choosing the **Select options** icon in the **Context Menu**



Following control options of all active totalizers (Integral or Counter) are available:

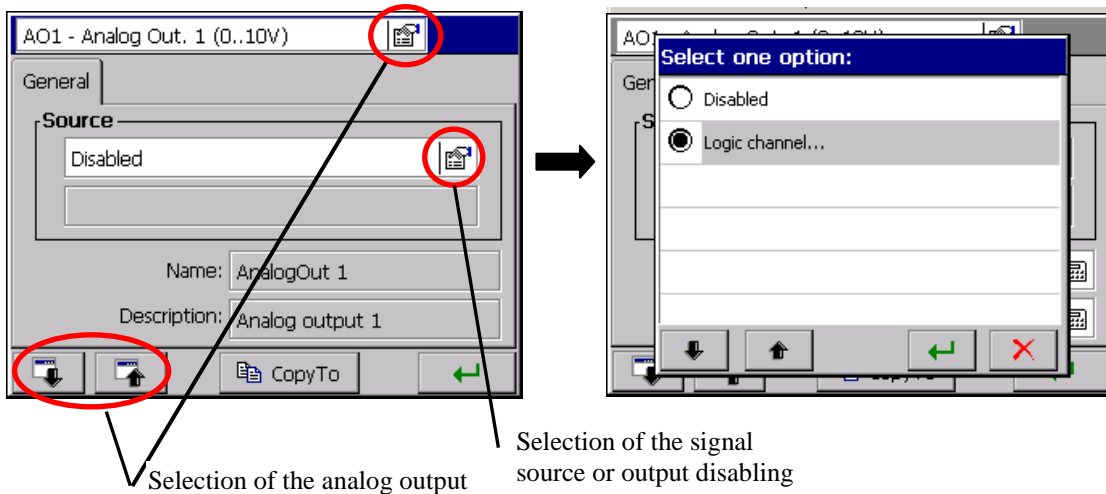
- **Reset all/selected:** Setting the state of all selected **totalizers** in logic channels on the level of programmed minimal values.  
**After setting minimal values, the restart of the totalizer work follows.**
- **Pause ON all/selected:** work stop of all active totalizers
- **Pause OFF all/selected:** work restart of all previously stopped totalizers.
- **Set start value:** sets new start value for a selected totalizer.

## 8.6. Programming outputs

### 8.6.1. Programming analog outputs

After selecting the **Outputs** icon in **KD7 Control Panel**, the window for the signal source selection (of the **Logic Channel 1..32**) is opened for 1...8 analog outputs.

Select the analog output (**AO 1..8**) from available outputs in the recorder, and assign the input signal source (**Logic Channel 1..32**) to it, in the **General** tab. The same logic channel or logic channel alarm can be the signal source for many analog outputs. If the signal source for the given analog output will be set as disabled, this output will be inactive.



On the analog output **AO 1..8**, the analog signal is available ( in limits of the output range), proportionally to the signal analog input from the logic channel for which following inputs are the source:

- Analog input **AI 1..12**, see section 7.10.3.2.
- Modbus Master input **CI 1..24** (with analog type of the output range), see section 7.10.3.1.
- Mathematical function **MT 1..16** (with analog type of the output range), see section 7.10.3.3.

The analog output **AO 1..8** can be the source of the logic signal **1** (Max output range) or **0** ( Min. output range) when it is controlled by the logic channel with the input signal of binary type:

- Binary input **BI 1..16** , see section 7.10.3.4.
- Alarm of the logic channel **1..32**, see section 7.10.3.5.
- Modbus Master input **CI 1..24** (with binary type of ythe output range), see section 7.10.3.4.
- Mathematic function **MT 1..16** ( with binary type of the output range), see section 7.10.3.3.

After the name and description edition, the programming of the selected analog output is ended.

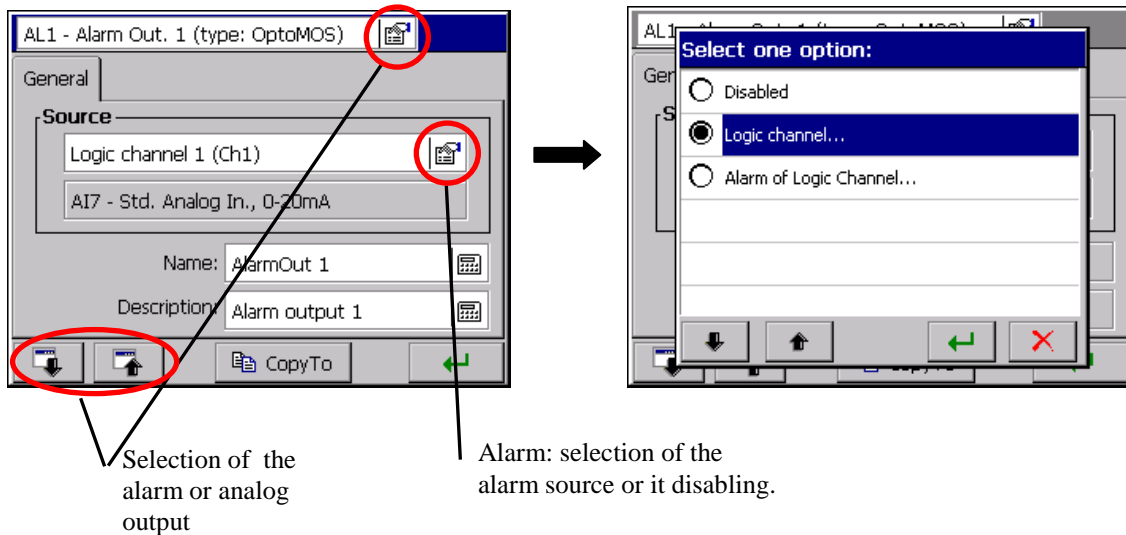


## 8.6.2. Programming alarm outputs

After selecting the **Outputs** icon in **KD7 Control Panel**, the window of the signal source selection (**Logic channel 1..32** or **Alarm of Logic Channel 1..32**) for **1..16** alarm outputs.

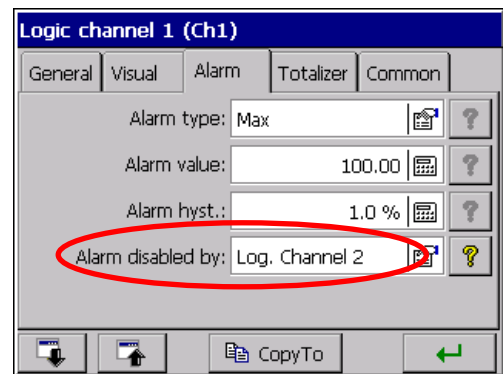
Select one from available alarm outputs (**AL 1..32**), assign to it in the **General** tab, the input signal source (**Logic channel 1..32** or **Alarm of Logic Channel 1..32**). The same logic channel or logic channel alarm can be the signal source for many alarm outputs.

If the signal source for the given alarm is set up as disabled, then this alarm will be inactive.



When selecting as the signal source of the analog output, on of the **Alarm of Logic Channel 1..32**, the type of alarm (Min or Max) and the output signal level at which the signal activation follows (shorting or opening of relay contacts) are set when configuring parameters of the logic channel (see section 8.5).

The alarm of the logic channel can be disabled by the logic state (1/ON) of the selected **Logic Channel 1..32**.



When selecting the **Logic Channel 1..32** as the signal source of the alarm output, the alarm is controlled by the logic signal output from the channel for which the input signals can be:

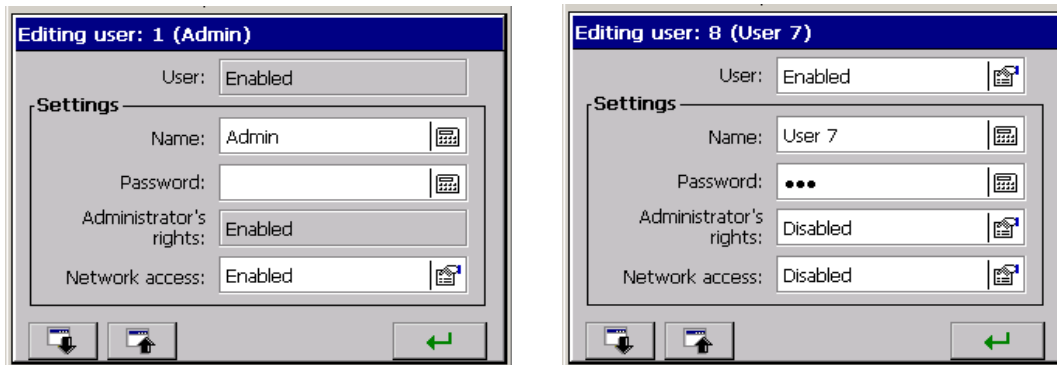
- Binary input **BI 1..16**, see section 7.10.3.4.
- Alarm of logic channel **1..32**, see section 7.10.3.5.
- Totalizer for the logic channel **1..32** (A1 or A2), see section 7.10.3.5
- Modbus Master input **CI 1..24**, see section 7.10.3.1
- Mathematic function **MT 1..16**, see section 7.10.3.3.
- Analog input **AI 1..12**, see the note below

Any analog output value of the logic channel **higher** than zero, will be interpreted as the logic state 1 (ON) of the given channel.



## 8.7 Edition of recorder users

After selecting the security icon in the **KD7 Control Panel**, one can set up parameters for individual recorder users in the **Editing user** window.



In KD7, 1...8 users can have access to configuration settings. The user 1 (**Admin**) has administrator's rights permanently. Only he can edit other users and change all settings related to them.

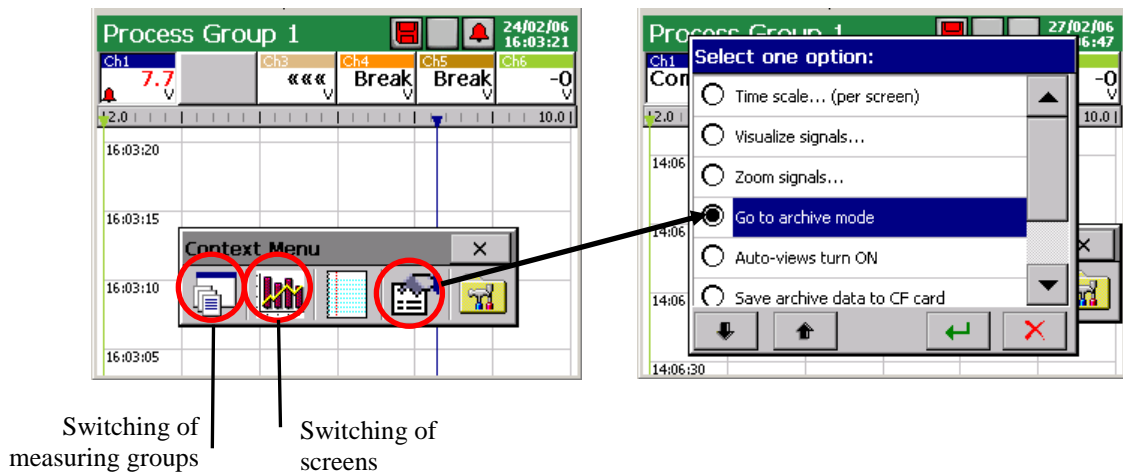
The user (User1..7) without administrator's rights can change only the access to the network, the name and the password in the edition window.


Only the **administrator** and **logged users** have access, after giving the password, to the options of recorder parameter configuration in the **KD7 Control Panel**.

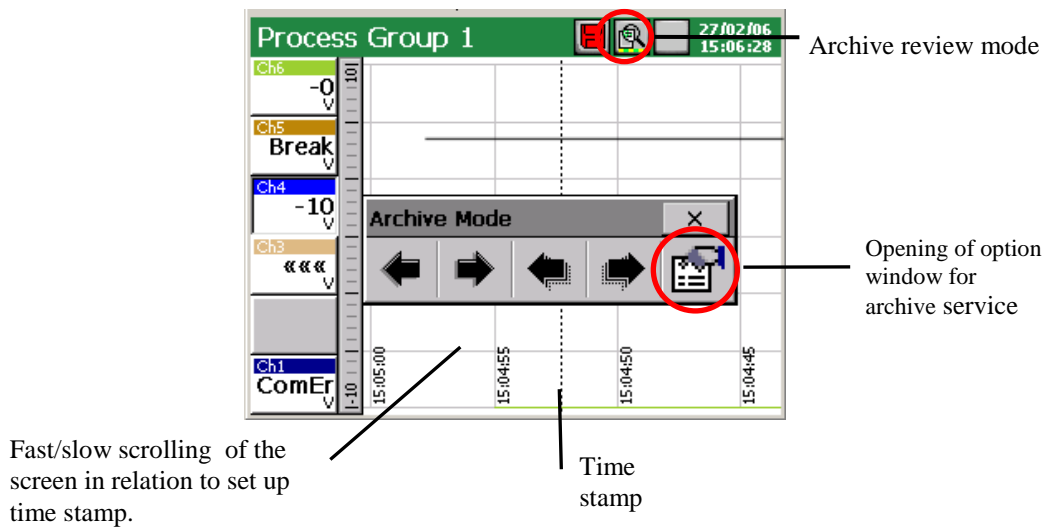
When writing the password, it is recommended to use only Latin alphabet and numbers without local chars (after changing the recorder menu language, one must preserve the possibility to introduce particular password signs).

## 8.8 Review of archived data

The review option menu of archive data stored in the buffer is available after switching the screen view into linear in the **Context Menu**, opening the selection window of currently available options and selecting **Go to archive mode** in it.

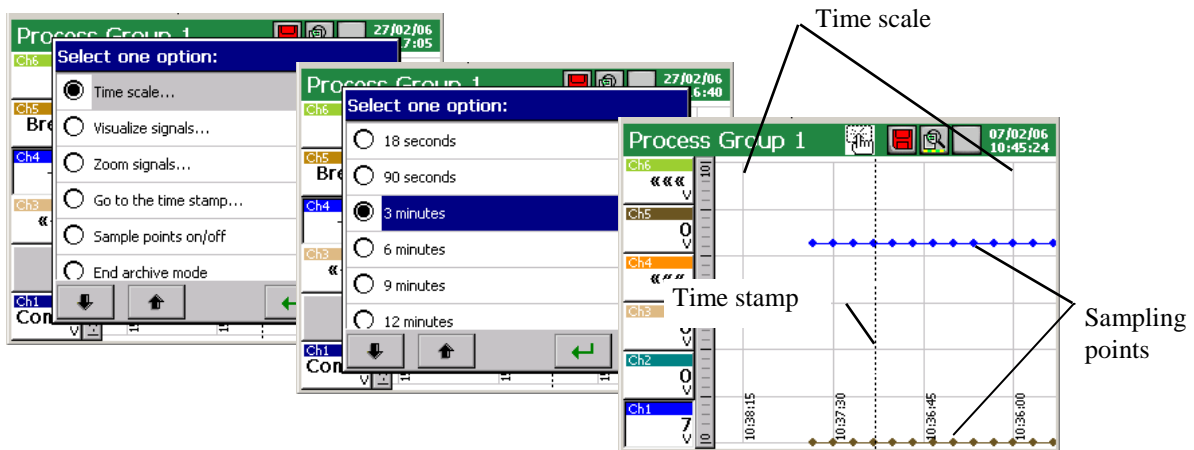


In the archive mode, after tapping the  icon or the screen in any place, the **Archive review mode** (arrows of slow and fast scrolling of the chart and the option icon for servicing archive data).



Following archive servicing options are available in the **Select one option** window:

- selection of the time scale for the archive chart,
- selection of visualized logic channels on the archive screen,
- enabled/disabled Zoom scale parameter (set up in the menu: ...**KD7 Control Panel**→**Inputs – Logic channel 1..32**→**Visual** →**Zoom scale** )
- setting of time stamp parameters on the archive screen,
- enabled/disabled sampling points ( - points corresponding to the data storage time )
- end of the archive review and exit to the visualization window of current measuring data.



The archive service concerns only data stored in the recorder buffer till the entry moment in the function of their review. During the archive review, current measuring data are stored in the buffer and will be serviced at the renewed entry into the archive.



After changing the recorder configuration, all archive data stored in the memory buffer are erased. If they are necessary, one must rewrite them previously on the CF memory card, (see section 8.1.6.)



After storing all the buffer capacity, successive measuring data are overwritten. If all data are necessary, one must previously empty the buffer rewriting data on the CF memory card, (see section 8.1.6.)

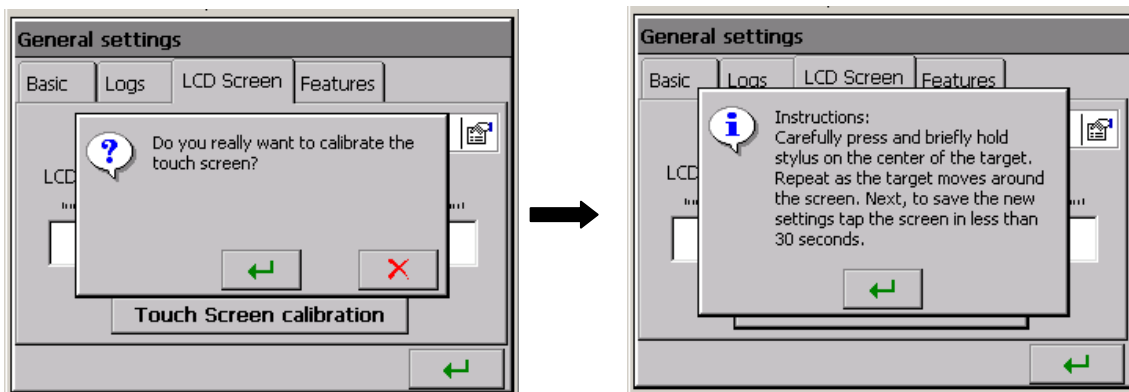
**The exit from the archive data review follows after selecting and accepting the End archive mode. A return to the current visualization of measurements follows.**

## 8.9 Calibration of the touch screen



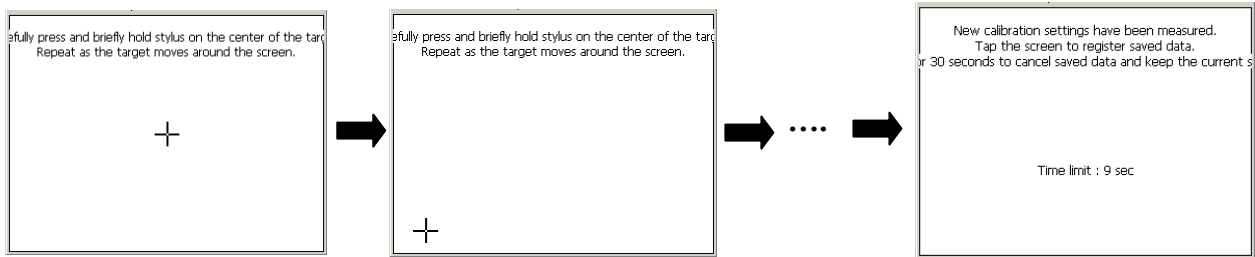
After selecting the **General settings** icon in the **KD7 Control Panel** window, on the **LCD screen** tab of the **General settings** window, the **Touch screen calibration** procedure is available.

One must carry out the touch screen calibration in case of incorrect reaction occurrence when pressing icons/buttons in displayed windows on the LCD screen.



After pressing the calibration button and confirming the selection and being acquainted with the instruction, the window in which one must confirm (by pressing) successive settings of the calibration mark is opening.

To save introduced changes in the touch screen calibration, please tap the screen (in any place) in less than 30 seconds since the setting of the last mark.



If the screen is not pressed within 30 seconds, changes in calibration will not be introduced.

### 8.10 Updating of the recorder software

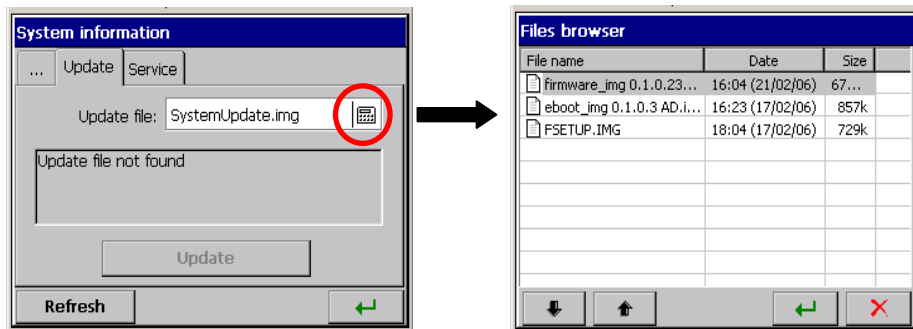
After selecting the **System information** icon in the **Update tab** of the **KD7 Control Panel** window, the updating procedure of the KD7 recorder is available.

The KD7 software is continually updated taking into consideration users' opinions about the KD7 recorder, and as development works will be conducted in the company. New software versions, in the form of updated files will be available for users interested in KD7 on the page:

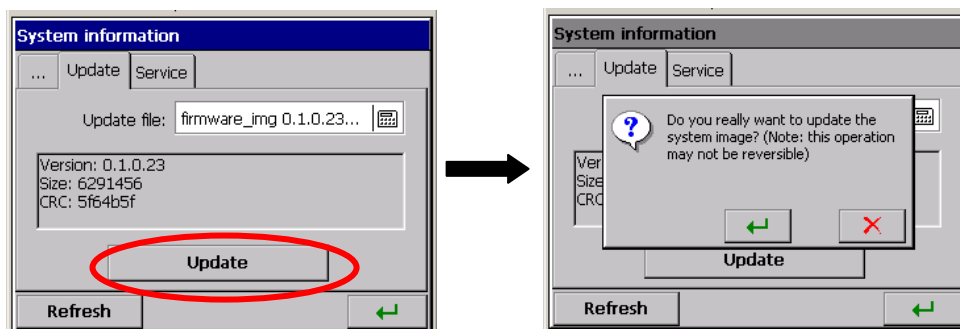
<http://www.lumel.com.pl>

After copying the file on the CF memory card (e.g. using the **KD Connect** program ( see section 9.1.)), one can update the recorder software. In order to do that, one must carry out following operations:

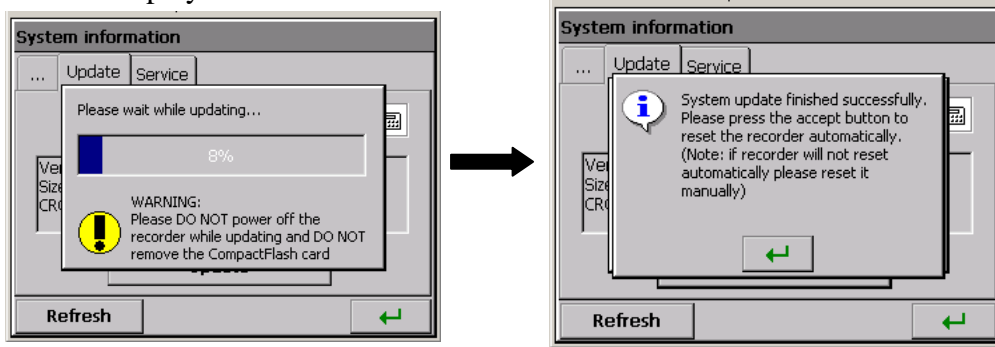
- a. Select the update file in the **Files Browser** window.



- b. Accept the selection and press the update button:



- c. After confirming the selection, the update begins and after its end, a message confirming its fulfilment is displayed.



Recorder's configuration is converted automatically after updating firmware (by saving automatically to file before update and automatically restoring it from file after update).

During the system update, one **must not turn the recorder off** and **must not take the CompactFlash out.**



### 8.11 Service of data stored on the CF card, visualization

Measuring data, separately for each group of logic channel, are stored in text files \*.CSV with or without the digital signature or in binary format with digital signature (see section 8.3). To check the digital signature in the data file, the **KD Check** program is destined (see section 9.3.).

The likelihood (digital signature) of data stored in the logic format is automatically checked during their scrolling and visualization in the **KD Archive** program (see chapter 9.4)  
 The limitation of the file capacity to 8 MB enables the direct review and visualization of data stored in the textual format \*.CSV, e.g. in the Excel program or OpenOffice Calc.

	A	B	C	D	E	F	G	
1	Time	Ch1	Ch2	Ch3	Ch4	Ch5	Ch6	Digital_Sign
2	07-06-09 15:56	27,2	27	27,1	27	26,9	26,8	
3	07-06-09 15:56	27,2	27	27	27	26,9	26,8	
4	07-06-09 15:56	27,2	27	27	27	26,9	26,8	
5	07-06-09 15:56	27,2	27,1	27,1	27	26,9	26,8	
6	07-06-09 15:56	27,2	27,1	27,1	27	26,9	26,8	
7	07-06-09 15:56	27,3	27,1	27,1	27	26,9	26,8	
8	07-06-09 15:56	27,3	27,1	27,1	27	26,9	26,8	
9	07-06-09 15:56	27,2	27,1	27,1	27	26,9	26,8	
10	07-06-09 15:56	27,2	27,1	27,1	27	26,9	26,8	

No of the logic channel in the group G7

Data from the memory card can be copied to a PC computer using the memory card reader servicing cards of CompactFlash type or taking advantage from features of the **KD Connect** program added to each delivered recorder.

The **KD Connect** program (see section 9.1) is destined for the communication between the PC computer and the KD7 recorder by means of the USB interface. It enables to carry out following operations:

- 1) copying files from the CompactFlash card, directly from the recorder on the PC computer ( e.g. data files, screen dumps)
- 2) uploading of files from the PC computer on the CompactFlash card in the recorder ( e.g. file with the updated KD7 software)
- 3) removal of accumulated files from the CompactFlash card in the recorder,

- 4) collection of current system information of the KD7 recorder (among others: system version, current configuration, degree of CompactFlash card fulfilling)

The **KD7 Setup** program (see section 9.2) enables to prepare in the PC a configuration file for the KD7 recorder. The appearance and service of the **KD7 Setup** program are the same as to the recorder service menu described in the user's manual. But, one must take notice of occurring differences:

- To service the **KD7 Setup** program, the mouse and computer keyboard are used.
- Dialogues of file selection allow reviewing the contents of computer disks.
- The language of the **KD7 Setup** program is compatible with the language of the last edited configuration.
- The appearance of dialogue windows highly depends on the system personalization (as e.g.: the size of systemic types).

The result of work with the KD7 Setup program is the configuration file for a recorder of a defined hardware configuration (kind and number of cards, settlement of slots).

The KD7 recorder renders accessible its own WWW server (see section 9.5) for the remote monitoring of measured values and the device state. Particularly, the recorder page allows to:

- obtain information about the device (serial number, device name and others),
- review current measuring values with a division in groups or without (list of all channels),
- access to data being in the CompactFlash Card,
- set the interval of the information update,
- select the language (can be independent from recorder language settings).

## 9. PROGRAMS ON PC

### 9.1 KD Connect Program

The **KD Connect** program is destined for the communication between the PC computer and the KD7 recorder by means of the USB interface.

The **KD Connect** program enables to carry out following operations:

- copying of files from the CompactFlash card, directly from the recorder into the PC computer (e.g. data files, screen dumps ),
- uploading of files from the PC computer into the CompactFlash card in the recorder (e.g. file with the updated KD7 software)
- delation of stored files in the recorder CompactFlash,
- sampling of current systemic information of the KD7 recorder (among others, system version, current configuration, degree of the CompactFlash filling)

#### 9.1.1 Installation of drivers for the KD7 recorder

One must install the driver in order to see correctly the KD7 touch screen recorder under the operating system MS Windows:

1. After connecting the recorder with the USB cable (delivered in the KD7 accessory set) to the free port in the computer, information about the detection of a new hardware appears in the computer.  
Next, the creator to detect the new hardware will be started.
2. One must insert the CD disk delivered with the KD7 recorder into the CD-ROM drive.
3. (This point concerns the XP system from SP2) . When asking: "**Can Windows system be connected with the WEB page .....**" One must mark the option "**No, not this time**"

4. The dialogue “Creator of hardware updating” appears .
5. One must select the option “**Install the software automatically**” and click “**Next**”.
6. One must select the found driver from the list and press “**Next**” to install the driver by the creator. When the creator inform about the lack of driver compatibility tests with Windows, one must answer “**Continue...**”. Next, click the button “**End**”.

After the correct driver installation (a restart of the system is not required) one can transit to the installation of the program delivered with the KD7 screen recorder.

Select the catalogue with the **KD Connect** program on the annexed CD disk and start the **KDConnect\_install.exe** program. The program installation creator will started. One must proceed in compliance with instructions displayed on the screen.

### 9.1.2 Installation of the KD Connect program

Program requirements:

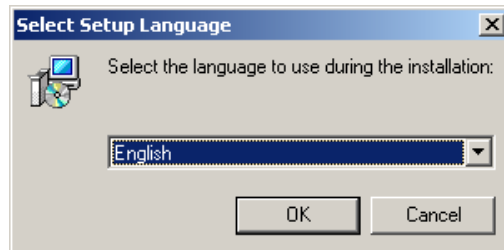
- Operating system: MS Windows 2000 or a newest one,
- Installed dedicated drivers for KD7 recorders,
- About 3 MB of free capacity in the hard disk,
- Other requirements equal to requirements makes demands of the operating systems

The program installation is typical for applications destined for the MS Windows environment. The program installation is in the annexed CD disk, in the “**KD Connect**” catalogue.

To begin the installation, one must start the Setup program being in the indicated catalogue. Next, one must proceed according to messages appearing on the screen.

The standard installation process has the following course:

1. Select the language used during the installation process

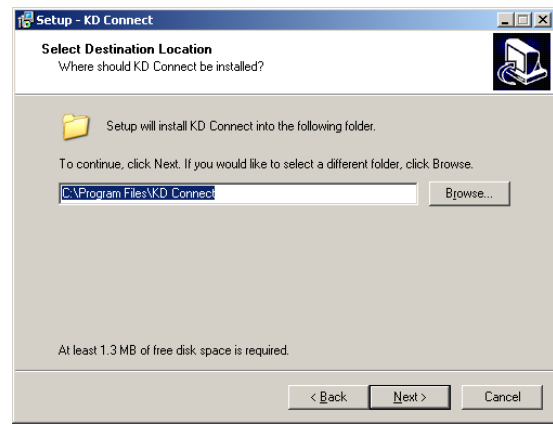


2. Welcoming window of the application installator

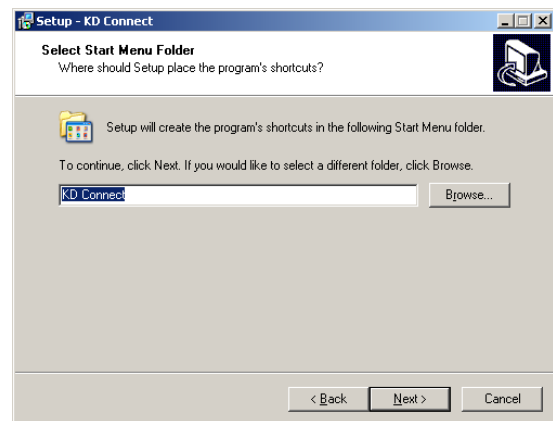




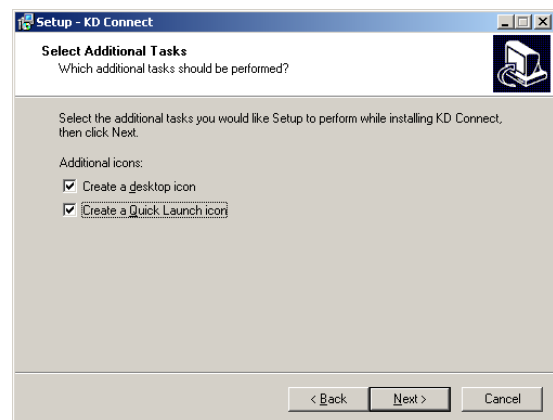
3. Selection of the in-coming catalogue for the application (**Note:** the installation in the default catalogue indicated by the installer is recommended)



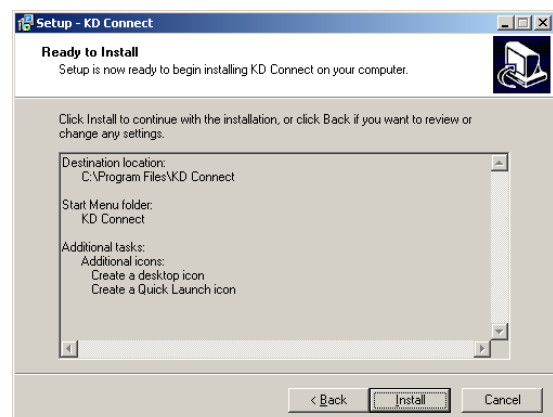
4. Selection of the group name for the Start menu



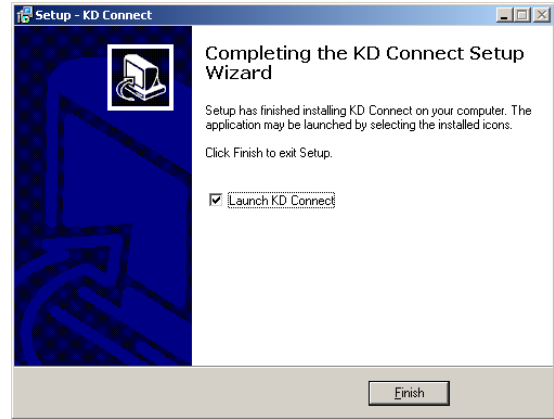
5. Possibility to insert shortcuts in different places of the desktop



6. Summary of carried out selections before the program installation.



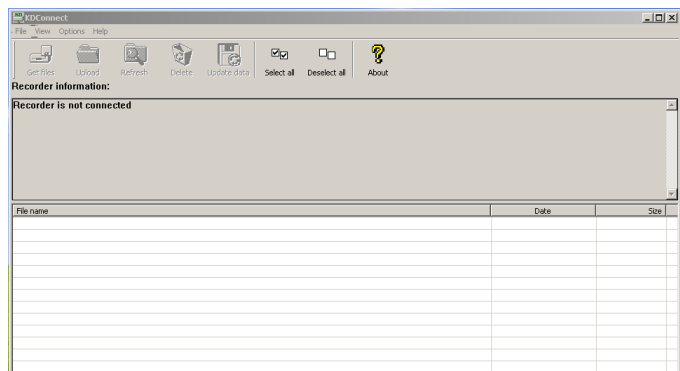
- Window informing about the successful end of the installation.



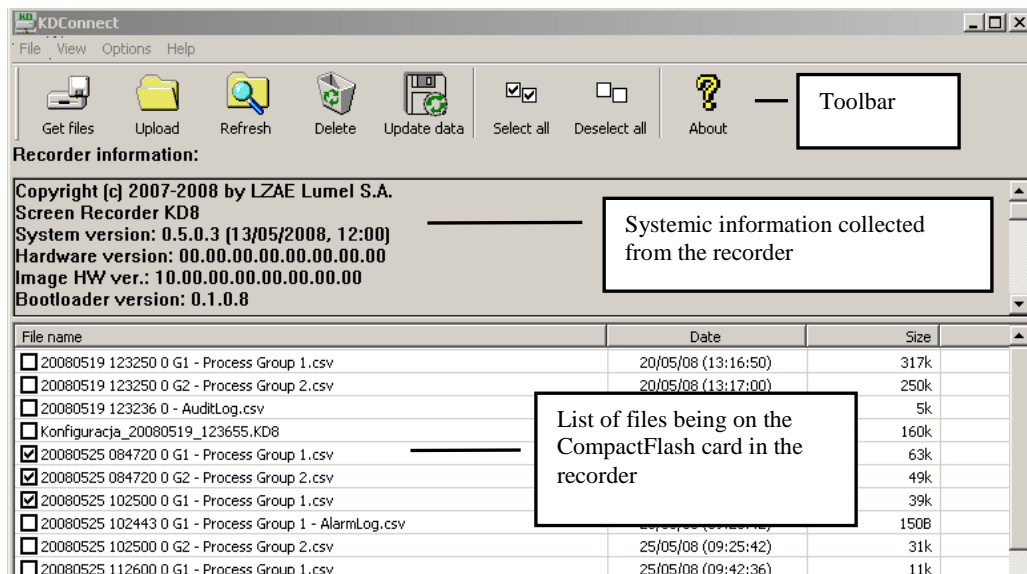
### 9.1.3 Program service

- Main application window**

The view of the main application window when the KD7 recorder is not connected (through the USB interface) to the PC computer, informs about this message in the information window and blanked icons on the toolbar



View on the main application window with the connected KD7 recorder to the PC.











- **Toolbar**

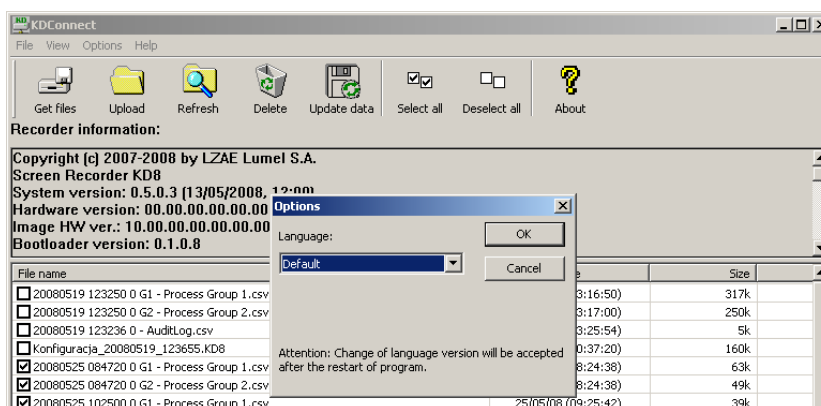
The application toolbar is situated on the upper part of the window and has the following appearance:



This toolbar allows to a quick access to the most important program options. Explanations of symbols are given below.

	Call of the collection option of marked files from the recorder into the PC computer.
	Upload the file from the PC computer into the CompactFlash installed in the recorder.
	Renewed collection of basic data from the recorder (systemic information and the list of files).
	Removal of marked files from the CompactFlash card installed in the recorder.
	Storage of all current measuring data from the buffer into CF
	Selects all files on the list of files
	Deselects all files on the list of files
	Shows the program information window.

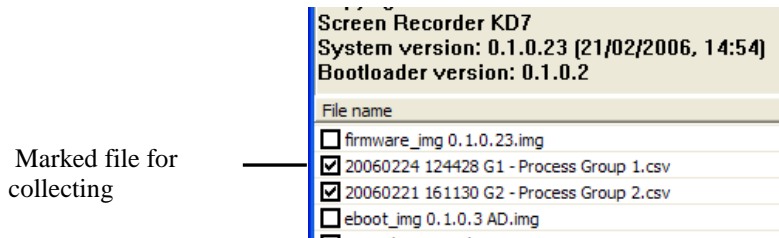
- **Program settings (Application menu → Options → Settings...)**



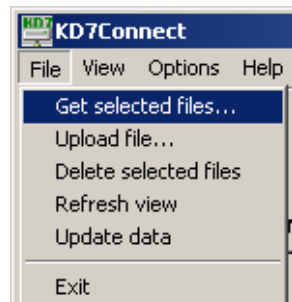
Program options allow to the change of application language settings. The selection of the language as **Default** means the application start in the language consistent with the language of the operating system if it is serviced by this program. In the contrary, the default language of the application is English.

- **Collecting function of files from the recorder (Application menu → files → Collect marked files...)**

To collect defined files from the recorder, one must mark them on the list of files ( in the square, next to the file name, the tick of marking appears).



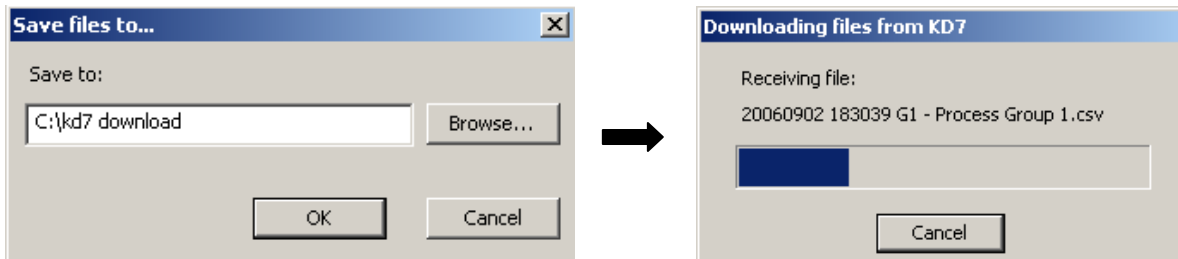
Next, one must call the option **Refresh marked files....**from the application menu.



or from the toolbar:



The window appears with the selection of the path for files recording in the PC computer :

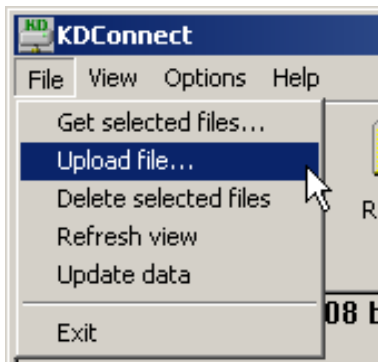


After confirming the in-coming path, the copying of files begins.

To collect the defined file and start it with a default servicing program, one can click twice on the file name.

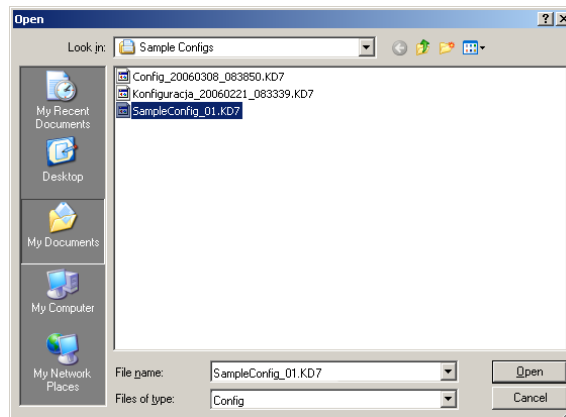
- **The function of uploading files to the recorder ( Application menu → Files → Upload files ...)** .

The option allows to upload any file from the PC computer into the CompactFlash card installed in the recorder. The command can be selected from the application menu.

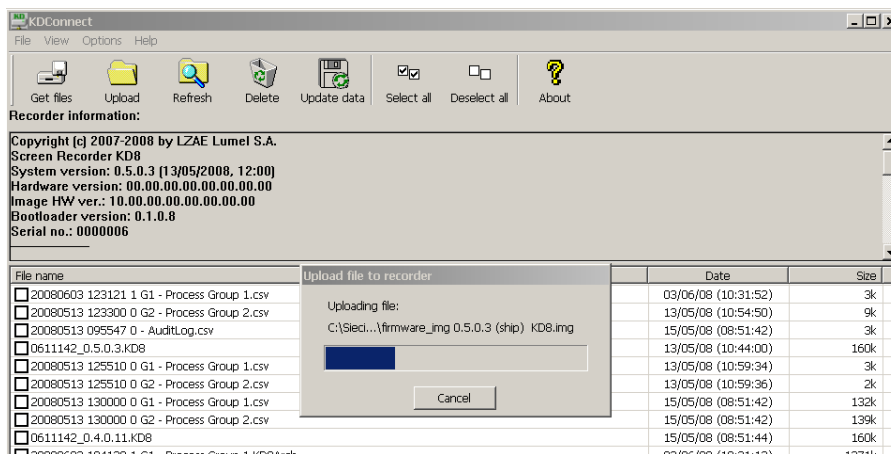


or from the toolbar:

The standard window for file selection will appear:



After selecting, the data transmission begins.

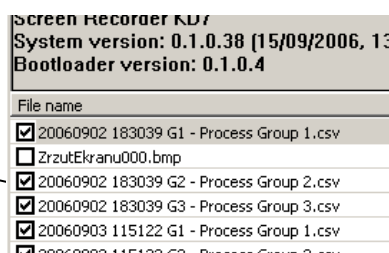


**Note:** The function is also serviced through the mechanism “Drag&Drop”. For this aim, one must drag the selected file, e.g. from the Explorer Windows on the area of the file lists of the **KD Connect** program.

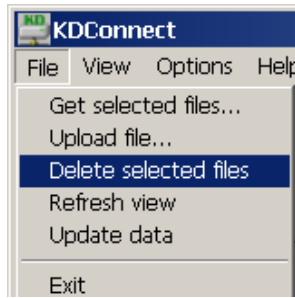
- **Data erase from the recorder (Application menu → Files → Delete selected files)**

To erase selected files from the CompactFlash card situated in the recorder, one must mark them previously (a tick mark appears in the square next to the file name):

Marked files to erase



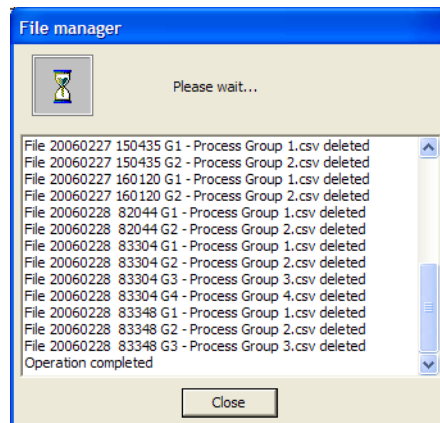
Next , one must choose the option **Delete selected files** from the application menu.



or the icon from the toolbar:



After selecting the command, the dialogue informing about the operation progress and its end will be displayed.

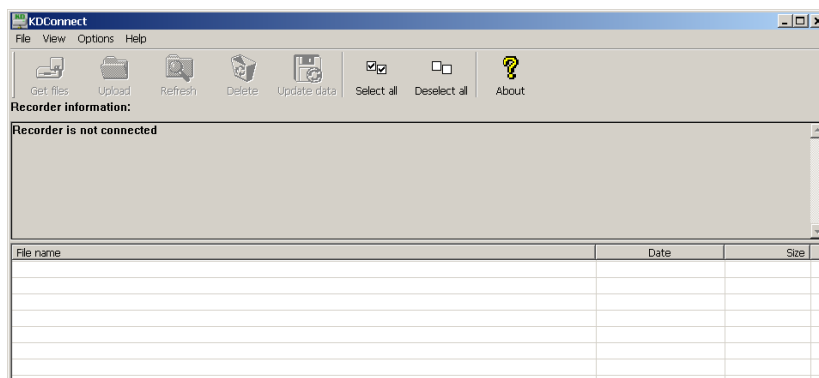


#### 9.1.4. Example of using the KD Connect program

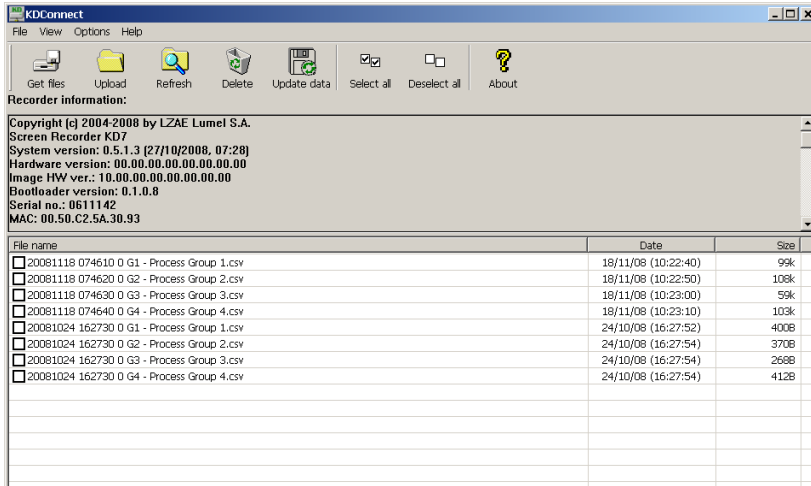
An example of the **KD Connect** program application for collecting archive data stored in the recorder is presented below. The goal is to show one of the method of data collecting from the CompactFlash card being in the recorder.

To get all data from the KD7 recorder in the PC computer, one must carry out following steps:

- Start the **KD Connect** program in the PC computer, which it was installed on,



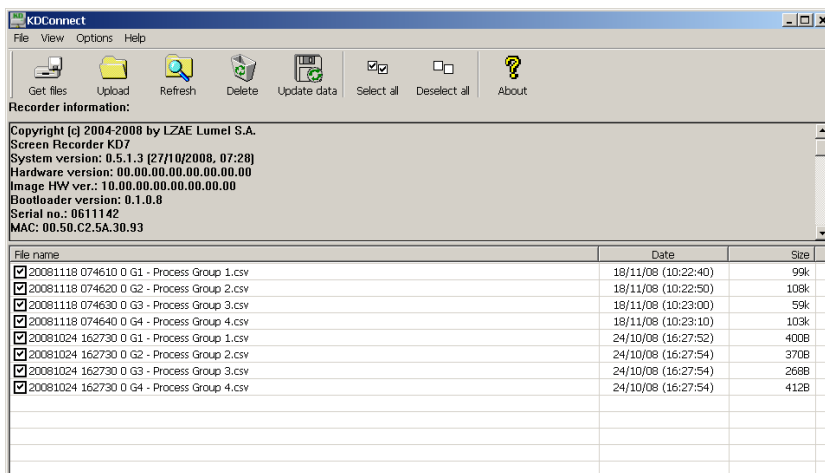
- Connect the KD7 recorder through the delivered USB cable to the free port in the PC computer. Then, information about the recorder and files stored on the CompactFlash card will be get. The application will update its view.



- One must select the **Select all** option from the program toolbar:



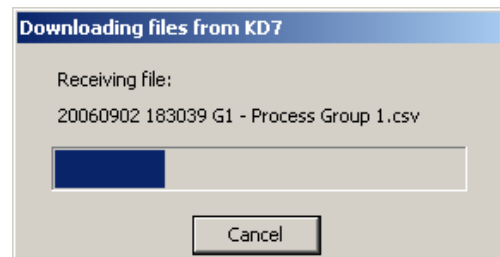
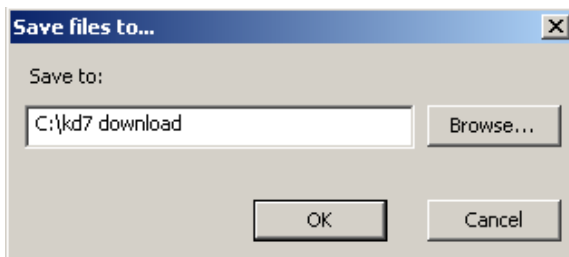
Then, all elements will be marked on the file list as files to get:



- Next one must select from the program toolbar the **Get Files** option



- The dialogue informing where the files will be stored is displayed. At this moment, one can also change the in-coming folder



After accepting the in-coming folder, the copying of files begins.

- In case of a successful end of the file collecting operation, the application transits again to collect information about the recorder and files being on the CompactFlash.

### 9.1.5. Error messages

Most often error messages which can occur during the work with the program are presented below:

<i>Message about error</i>	<i>Proposed solution</i>
Communication error with the device (error code: 101)	[1] One must check the correctness of the KD7 recorder physical connection to the PC computer through the USB cable. [2] Make the restart of the computer and the recorder.
Error: the notification recording does not succeed (error code: 102)	Systemic error occurred. One must start the computer again.
Error: the communication does not succeed (error code : 103)	During the communication an error occurred. It is recommended to proceed like in the case of the error code 101.
Input/output error of the host (recording/creation of file) ) Be sure that appropriate recording rights are set up and there is a lot of capacity in the in-coming catalogue.	There is an error on the PC computer side. It is probably related with input/output operations. One must be sure that there is sufficiently of capacity on the in-coming disk for data from the recorder.
The device breaks the uploading	The device was disconnected or broke the uploading because of errors.
General error code (error code:987)	A critical error occurred. One must proceed according to the error code 101.
Device error: lack of capacity on the CompactFlash support.	Error from the recorder side. Lack of capacity on the CompactFlash card for uploaded data.
Device error: lack of the CompactFlash support in the device!	Error from the recorder side. Lack of CompactFlash card. One cannot upload data in the recorder

## 9.2 KD7 Setup program

**KD7 Setup** is a program enabling to prepare a configuration file in the PC computer for the KD7 recorder.

After recopying the configuration on the CF memory card, it can be used for reprogramming of settings in the given KD7 recorder.

### 9.2.1 Installation

The software installation is typical for application destined for the MS Windows environment. The installation program is situated on the annexed CD disk to the recorder, in the “**KD7 Setup**” catalogue. To begin the program installation, one must start the installation program **KD7Setup\_install.exe** being in the indicated catalogue.

Next, one must proceed according to messages appearing on the screen (like in the description of the **KD Connect** program installation).



## 9.2.2 Program service

The appearance and service of the **KD7 Setup** program is the same from the service menu of the recorder described in the user's manual. However, one must observe occurring differences:

- For servicing the **KD7 Setup** program, the mouse and the PC computer keypad are used,
- Dialogues of file selection allow to browse the contents of computer disks,
- The language of the **KD7 Setup** program is in compliance with the language of lately edited configuration,
- The appearance of dialogue windows depends notably on the system personalization (e.g. the size of systemic character types)

The result of work with the **KD7 Setup** program is the configuration file for the recorder with a defined hardware configuration (kinds and number of cards, settlement of slots).

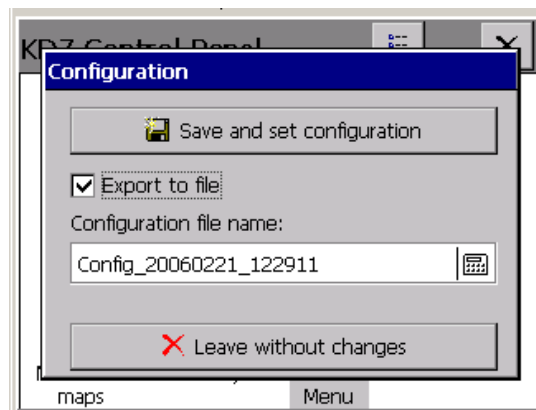
**One cannot install this file in a recorder with another hardware configuration.**

An example of the **KD7 Setup** application, in order to generate the configuration file on a PC computer is presented below, for carry out setting changes in the KD7 recorder.

In the instruction below, one must differentiate operations made in the recorder and operations made in the PC computer.

### - On the KD7 recorder side

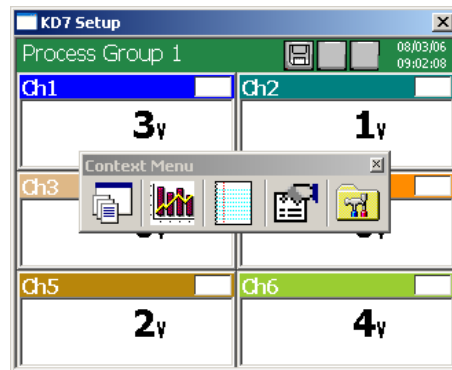
- a. Record the current KD7 configuration file on the CompactFlash card  
Mark the option **Export to file** in the output dialogue from the **KD7 Control Panel** and give the appropriate name to the file (or remain the proposed name). Next, store the configuration. (option: **Save and set configuration**)



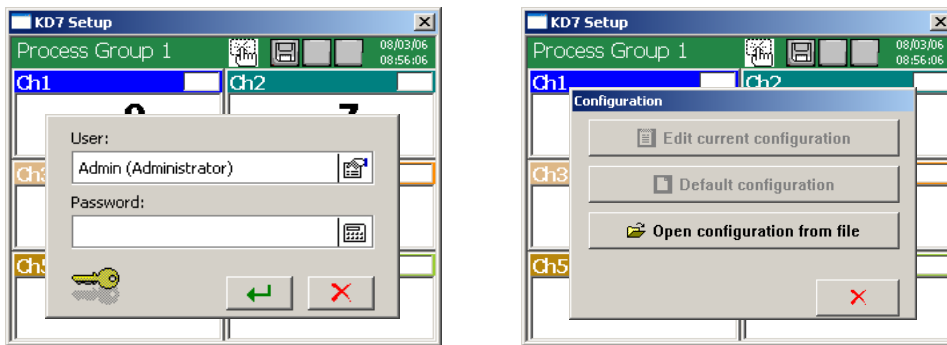
- b. Upload the recorded configuration file to the PC computer by means of one of the recorder communication interfaces. One can do this by means of the USB interface program and the **KD Connect** program (see section 9) or through the Ethernet interface.

- On the PC computer side

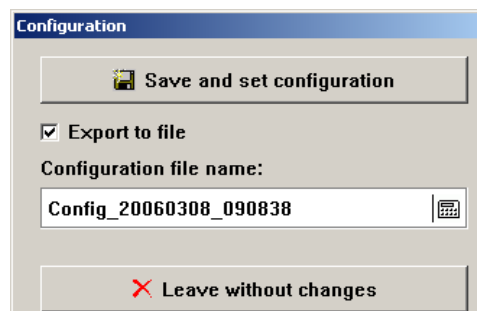
- a. Start the **KD7 Setup** program, call the context menu (tap on the area of the recorder screen), and next press the input icon in order to configure the recorder.



- b. The logging dialogue appears. One must transit into the configuration dialogue.



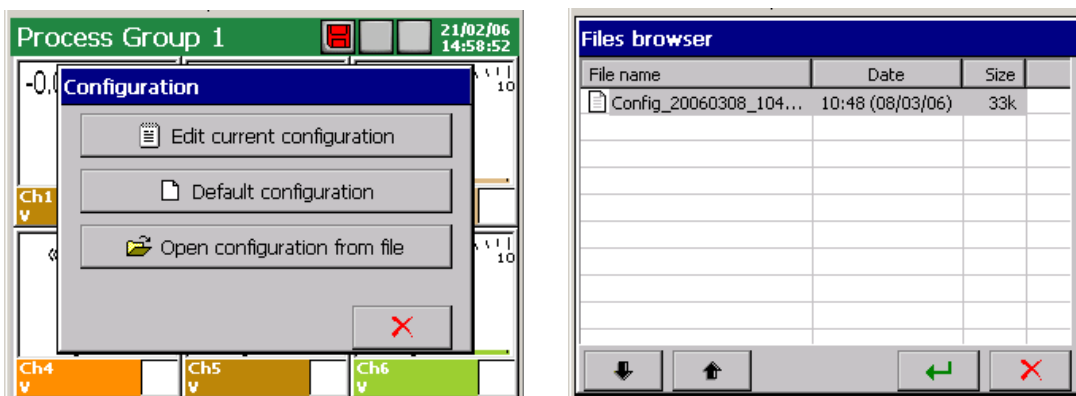
- c. At the first configuration, one can select the only available the option **Open configuration from file**. The standard dialogue of the Windows system appears to open files. One must select the previously saved configuration file.
- d. After reading the configuration file in, the transition to the **KD7 Control Panel** follows. At this moment, one can perform changes in the recorder configuration.
- e. After finishing configuration operations, one must give a name to the new configuration file and save it in the PC computer disk (selecting the appropriate name for the configuration and in-coming folder).



- f. Next, one must such saved configuration upload from the PC computer to the recorder. One can do that, e.g. by means of the **KD Connect** program or through the CompactFlash card. (to save the file in the CF card, one can use a standard commercial reader of memory card).

- **On the KD7 recorder side**

- a. On can get the saved configuration in KD7 from the CF card and open after transiting to the **KD7 Control Panel – Configuration**, option: **Open configuration from file**.
- b. After reading out the configuration, it is edited on the recorder screen.



During the first run of the application you will be asked for a License Key File. Please follow the messages that appear on the screen. If you do not have the license key the application will run in demo mode.

### 9.3 KD Check program

The KDCheck program is destined for the verification of file correctness with measuring data saved in the CSV with digital signature format (see section 8.3.)

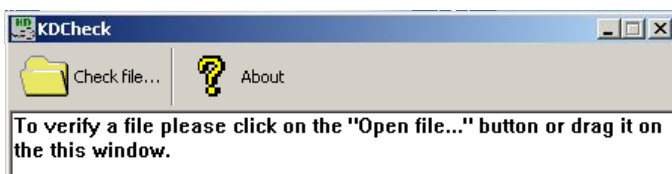
The program installation is typical for application destined for the MS Windows environment.

The installation program is situated on the annexed CD disk to the delivered recorder.

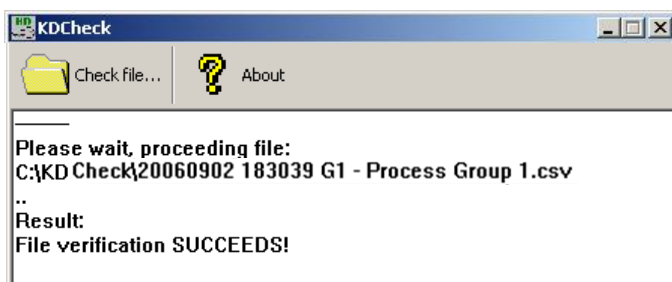
To begin the program installation, one must start the **KDCheck\_install.exe** installation program.

The creator of program installation will start. Please follow the instruction displayed on the screen.

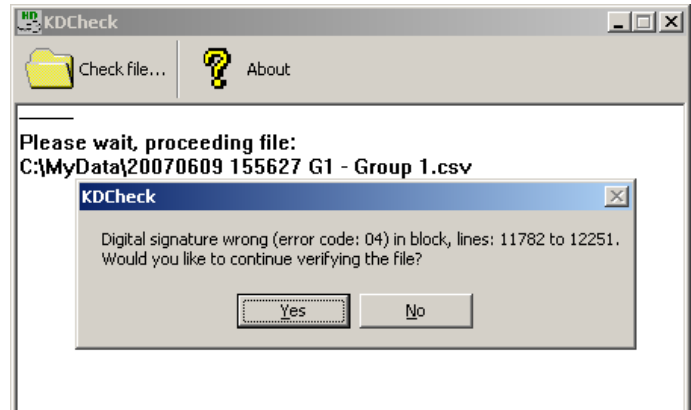
Selection and file check



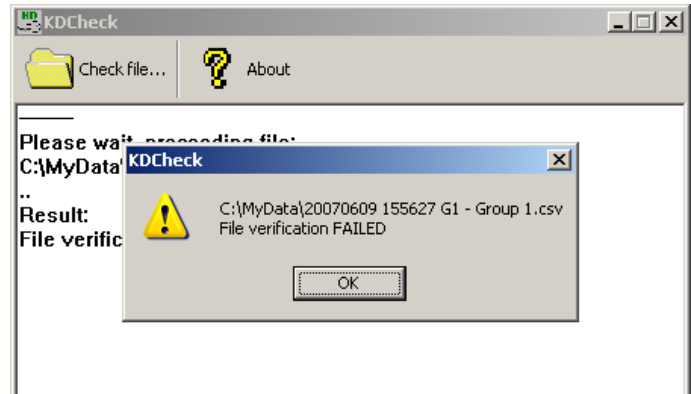
**Check result:**  
Correct verification  
of the file



Information about the block in which we state discordance of the digital signature with saved date



**Check result:**  
Wrong verification of the file.



#### 9.4. KD Archive program

The KD Archive program is destined for visualization and analysis of archived measuring data stored in binary format in the CF card.

The software installation is typical for applications destined for the MS Windows environment (MS Windows XP or a newest one).

The installation program and service manual of the **KD Archive** program are in the added CD to the recorder. In order to start the program installation, one must start the installation program **KDArchive\_install.exe**. The creator of the software installation will be started. One must proceed according to instructions displayed on the screen.

During the first run of the application you will be asked for the License Key File. Please follow the messages that appear on the screen.

#### 9.5 Service of the WWW server

The KD7 recorder renders accessible its own WWW server for the remote monitoring of measuring values and the device state. In particular, the recorder side allows to:

- obtain information about the device (serial number, device number and others),
- monitor current measuring values with or without the partition into groups (list of all channels),
- access to data being in the CompactFlash card,
- set up the interval of the information update,
- select the language for the side (it can be independent from recorder language settings)

**Note:**

The recorder WWW page is compatible with the majority of internet browsers accessible on the market. However it is recommended to browse it with a minimal resolution: 1024 x 768.

The connection of JavaScript. service is recommended.

## 9.5.1 General view

*Selection of channel group*

*Language selection*

*Current measuring values*

*Frequency of the page updating*

Channel No.	Name	Description	Value	Unit	State
1	Ch1	Channel 1	-2047	mV	
2	Ch2	Channel 2	-2047	mV	
3	Ch3	Channel 3	-2047	mV	
4	Ch4	Channel 4	-2046	mV	
5	Ch5	Channel 5	-2045	mV	
6	Ch6	Channel 6	-2045	mV	
7	Ch7	Channel 7	0.95	V	

## 9.5.2 View of the window to browse data from the CF card

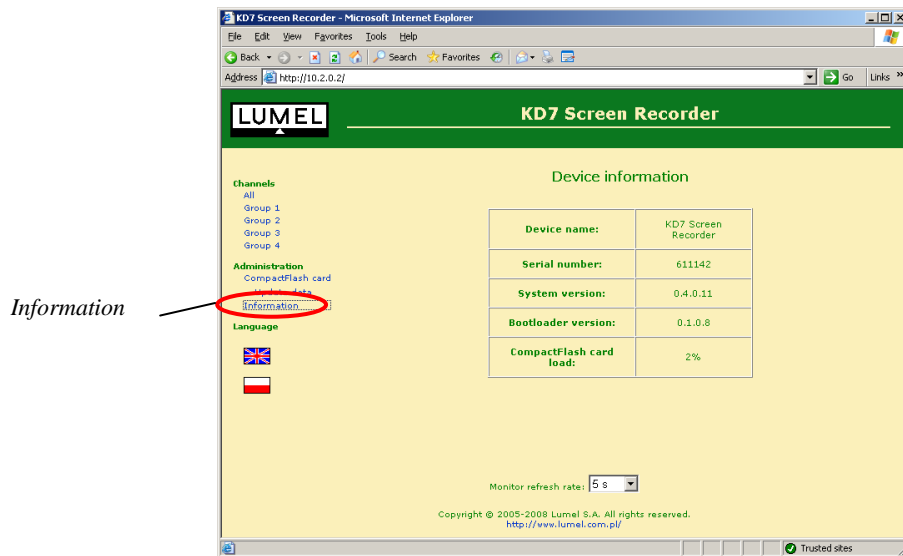
*Save archive data to CF card*

**ScreenRecorder - /StorageCard/KD7/**

[\[To Parent Directory\]](#)

6/13/2008	12:00 AM	38046	20080529_112050_0 G1 - Process Group 1.csv
6/13/2008	12:00 AM	21700	20080529_112050_0 G2 - Process Group 2.csv
6/13/2008	12:00 AM	21744	20080529_112050_0 G3 - Process Group 3.csv
6/13/2008	12:00 AM	38064	20080529_112050_0 G4 - Process Group 4.csv
6/13/2008	12:00 AM	1326	20080529_112032_0 - AuditLog.csv
6/13/2008	12:00 AM	1178	20080613_142350_0 G1 - Process Group 1.csv
6/13/2008	12:00 AM	666	20080613_142350_0 G2 - Process Group 2.csv
6/13/2008	12:00 AM	710	20080613_142350_0 G3 - Process Group 3.csv
6/13/2008	12:00 AM	1190	20080613_142350_0 G4 - Process Group 4.csv

### 9.5.3 View of the window with information about the KD7 recorder.



### 9.5.4 Configuration

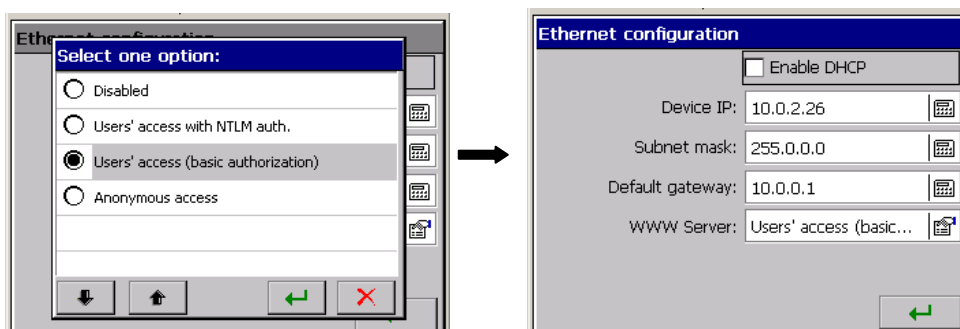
To obtain the access to the server, it is necessary to connect the recorder to the Ethernet network working in compliance with the TCP/IP protocol and carry out a suitable configuration in the **KD7 Control Panel** (Ethernet icon). In case of problems, contact the network administrator.

We obtain the access to the server after writing the recorder IP address in the internet browser, e.g.: <http://10.0.1.2> (where 10.0.1.2 is the defined recorder address or the address defined by the server in case of using the DHCP service).

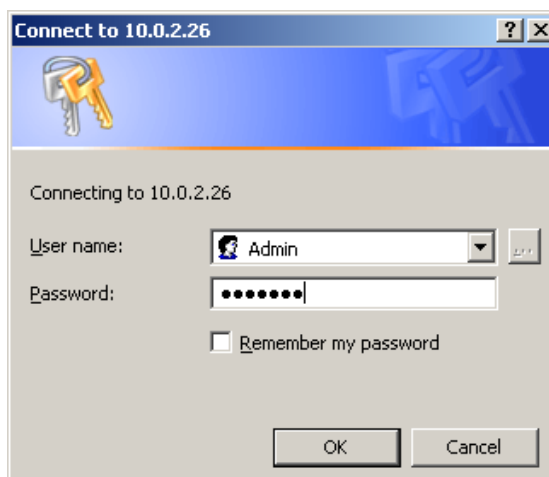
#### Note:

1. Check the Ethernet configuration correctness in the KD7 recorder through giving the command *'ping adres\_of\_the\_device'* in the PC system \* ...PC (**Start – Open: ping...**). In order to obtain precise information about the action of the *ping* command, one must look in the description of the PC system.
2. Depending on the configuration, in Ethernet options and in users' edition options of the recorder (see section 11), the access to WWW page can be suitably secured.

If the access to KD7 is authorized (for a current user, the access password is set for the KD7 configuration) and in Ethernet configuration options, the access is selected with the NTLM authorization or with the basic authorization. .



The logging window appears, in which, one must give user's data:



### 9.5.5 Symbols of the KD7 recorder on the web page

Following marks are used by the recorder WWW page.

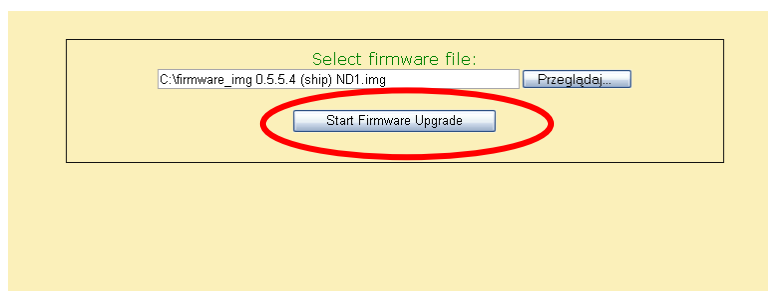
<i>Symbol</i>	<i>Meaning</i>
	Overflow of the upper range
	Overflow of the lower range
	Alarm
	Language symbol

### 9.5.6 Firmware update thru the device web page

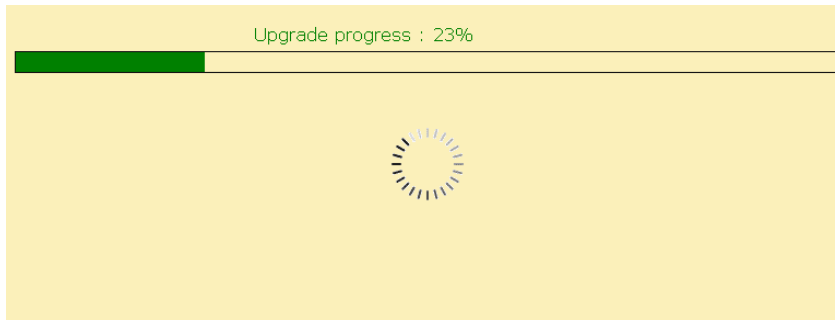
System update is also available from the device web page. Only users with administrator rights are granted access to the web update process. It is recommended to set a non empty password for these accounts.

After selecting an update file and pressing the **Start Firmware Upgrade** button the following operations follows:

- a) update file is sent to a device CF card,
- b) system file verification,
- c) system update,
- d) remote device reset.



After sending an update file on the CF card the update progress appears. If system update finishes and device resets with success the main page will be displayed.



### 9.5.7 FTP Download Application

The **FTP Download** is an application to automate a download process of data files from a device to PC. It can be easily used in batch files (\*.bat) to periodically copy files to a local directory. The advantage of this program is that it copies only newest data from the source directory, i.e. files that changed or were newly created. The syntax is following:

```
FTPDownload IPAddress Port UserName Password  
SourcePath DestinationPath
```

The exemplary batch file could be as follows:

```
ECHO Download data from ND1, IP: 10.0.0.4 Port: 21  
FTPDownload 10.0.0.4 21 Admin pass123 /CF/ "C:\Data from ND1"
```



In order to automate data download process from the device it is recommended to schedule a new task in Windows XP Task Scheduler.

---



## 10. TECHNICAL DATA

### ▪ Programmable measuring system:

- number of measuring channels: 3, 6 or 12
- input resistance > 10 MΩ (U, TC); =100 Ω (I)
- sampling rate 350 ms (for 1 measuring place)
- measuring accuracy according to the table 1
- additional measuring error with the automatic temperature compensation of the thermocouple reference cold junctions ≤ 1°C
- isolation between measuring places 100 V d.c.
- isolation measuring place-housing 500 V d.c.

### Measuring ranges (universal measuring inputs) / Measuring accuracy:

*Table 1*

Input signal	Signal symbol in the menu	Measuring range / Measuring accuracy (%)		Minimal sub-range / Measuring accuracy (%)	
		3	4	5	6
1	2	3	4	5	6
Voltage	mV	0... ± 9999 mV	0.15	5 mV	0.25
Current	mA	0...±20 mA	0.15	1 mA	0.25
Thermocouple (TC):					
<b>J</b> ( Fe - CuNi ) <sup>1)</sup>	TC <b>J</b>	-200...1200 °C	0.1	100 °C	1
<b>K</b> ( NiCr - NiAl ) <sup>1)</sup>	TC <b>K</b>	- 200...1370 °C	0.1	130 °C	0.7
<b>N</b> ( NiCrSi - Ni Si ) <sup>1)</sup>	TC <b>N</b>	-200...1300 °C	0.1	200 °C	0.5
<b>E</b> ( NiCr-CuNi ) <sup>1)</sup>	TC <b>E</b>	-200...1000 °C	0.1	100 °C	1
<b>R</b> ( PtRh13 - Pt ) <sup>1)</sup>	TC <b>R</b>	0...1760 °C	0.2	540 °C	0.3
<b>S</b> ( PtRh10 - Pt ) <sup>1)</sup>	TC <b>S</b>	0...1760 °C	0.2	570 °C	0.3
<b>T</b> ( Cu- CuNi ) <sup>1)</sup>	TC <b>T</b>	-200...400 °C	0.1	110 °C	0.9
<b>B</b> ( PtRh30 - PtRh6 ) <sup>1)</sup>	TC <b>B</b>	400...1820 °C	0.2	1000 °C	0.3
<b>L</b> (GOST) <sup>2)</sup>	TC <b>TXK</b> (GOST)	-200 800	0.1	90 °C	0.3
<b>K</b> (GOST) <sup>2)</sup>	TC <b>TXA</b> (GOST)	-200 1370	0.1	130 °C	0.7
Resist. thermometer (RTD):					
<b>Pt 100</b> <sup>3)</sup>	<b>Pt 100</b>	- 200...850 °C	0.15	50 °C	0.25
<b>Pt 500</b> <sup>3)</sup>	<b>Pt 500</b>	- 200...850 °C	0.3		0.5
<b>Pt 1000</b> <sup>3)</sup>	<b>Pt 1000</b>	- 200...850 °C	0.3		0.5
<b>Ni 100</b> <sup>3)</sup>	<b>Ni 100</b>	- 60...180 °C	0.15		0.25
<b>Ni 90,26</b>	<b>Ni 90,26 (P1)</b>	- 50...150 °C	0.15		0.25
<b>Cu 100</b> <sup>3)</sup>	<b>Cu 100</b>	-50...180 °C	0.15		0.25
<b>GR.21</b> (GOST'78) <sup>4)</sup>	<b>GR.21</b> (GOST'78)	-260...1100 °C	0.15		0.25
<b>GR.21</b> (GOST'94) <sup>5)</sup>	<b>GR.21</b> (GOST'94)	-260...1100 °C	0.15		0.25
<b>50P</b> (GOST'78) <sup>4)</sup>	<b>50P</b> (GOST'78)	-260...1100 °C	0.15		0.25
<b>50P</b> (GOST'94) <sup>5)</sup>	<b>50P</b> (GOST'94)	-260...1100 °C	0.15		0.25
<b>100P</b> (GOST'78) <sup>4)</sup>	<b>100P</b> (GOST'78)	-260...1100 °C	0.15		0.25
<b>100P</b> (GOST'94) <sup>5)</sup>	<b>100P</b> (GOST'94)	-200...200°C	0.15		0.25
<b>50M</b> (GOST'78) <sup>4)</sup>	<b>50M</b> (GOST'78)	-200...200°C	0.15		0.25
<b>50M</b> (GOST'94) <sup>5)</sup>	<b>50M</b> (GOST'94)	-200...200°C	0.15		0.25
<b>100M</b> (GOST'78) <sup>4)</sup>	<b>100M</b> (GOST'78)	-200...200°C	0.15		0.25
<b>100M</b> (GOST'94) <sup>5)</sup>	<b>100M</b> (GOST'94)	-200...200°C	0.15		0.25
Potentiometric transmitter	Pot. Trans.	0...2000 Ω	0.15	100 Ω	0.25
Resistance transmitter	Res. Trans.	0...2000 Ω	0.15	100 Ω	0.25

1) Characteristics of thermocouples: acc. to EN 60584-1

2) Characteristics of thermocouples: acc. to GOST R 8.585-2001

3) Characteristics of resistance thermometers: acc. to EN 60751+A2

4) Characteristics of resistance thermometers: acc. to GOST 6651-78

5) Characteristics of resistance thermometers: acc. to GOST 6651-94

6) From firmware version: 0.5.6.23

Rated operating conditions and additional errors:

Table 2

Influencing quantity or influencing factor	Value, range or reference conditions	Number of the range type	Measurement additional errors or attenuation
1	2	3	4
Ambient temperature	0...23...50°C	01...13	0.25 / 10°C
Supply voltage	90...253 V a.c. (40...50...400) Hz lub 90...300 V d.c. 18...30 V d.c.	01...13	0.2 % × range
External magnetic field	0...400 A/m	01...13	0.1 % × range
Resistance of the external measuring circuits	0...1 kΩ	01	< 50 μV / 1 kΩ
	-	02	-
	0...50 Ω / lead <sup>1)</sup>	03, 04	< 0.05 Ω
	0...100 Ω	05...11	< 5.0 μV / 100 Ω
	0...50 Ω / lead <sup>1)</sup>	12, 13	< 0.2 °C
Interferences by the serial component: 50 and 100 Hz for a 50 Hz supply network 60 and 120 Hz for a 50Hz supply network	Up to 2.5 x max value in the programmed range For a measured voltage above 5 V it diminishes to the value x 1.2, at 10 V	01...13	≥ 60 dB
Interferences by the parallel component of the d.c. and a.c. voltage: 50 and 100 Hz for a 50 Hz supply network 60 and 120 Hz for a 60 Hz supply network	100 V a.c. voltage 100 V d.c. voltage	01...13	≥ 90 dB

1) Resistances of leading wire connections should be equal. A difference of the resistances causes additional measuring error.

▪ **Standard measuring system (version acc. to the ordering code):**

- number of measuring channels 3, 6 or 12
- measuring ranges:
  - voltage measurement 0...10 V, input resistance > 1 MΩ
  - current measurement 0...20 mA / 4...20 mA, input resistance < 10 Ω
- isolation between measuring channels: 500 V d.c.
- isolation between measuring channels and the housing: 500 V d.c.
- measurement accuracy 0.25 % of the measuring range
- measurement time of a single input minimum 100 ms

▪ **Admissible overload in the measuring system**

acc. to EN 60051-8

▪ **Logic inputs:**

- control signal 8 (or 16), with a common mass  
0/5...24 V d.c.
- switching frequency up to 50 Hz, (depending on equipment configuration)
- isolation to the housing 500 V d.c.

▪ **Analog outputs**

- Current:** 4 (or 8) galvanically isolated
- output signal 0...5 mA ,0...20 mA or 4..20 mA
  - additional error 0.2%
  - load resistance < 500 Ω

- isolation to the housing	500 V d.c.
<b>Voltage:</b>	4 (or 8) galvanically isolated
- output signal	0...5 V, 1..5V load resistance $\geq 250 \Omega$ or 0...10 V, load resistance $\geq 500 \Omega$
- additional error	0.2%
- isolation to the housing	500 V d.c.
<b>Alarms</b>	
<b>Electromagnetic relays:</b>	8 (or 16), programmable
- load capacity for resistance load	AC max: 250V a.c., 1A DC max: 30 V d.c., 1A
<b>OptoMOS relays:</b>	8 (or 16), programmable
- load capacity for resistance load	$\leq 85$ V d.c., 100 mA $\leq 60$ V a.c., 70 mA
- current peak value	300 mA/10 ms
- OptoMOS resistance	ca 8 $\Omega$
- protection against a too excessive current,	SMD type F 125 V/125 mA (SIBA)
- protection against an excessive voltage when switching an inductive load	For the current accretion rate: $\leq 5$ A/s – from the 0 mA value $\leq 1.5$ A – from the 100 mA value external system (varistor, transil, triac)
<b>Interfaces:</b>	
- RS-232	transmission protocol: MODBUS SLAVE baud rate: 300...256000 bit/s transmission mode: ASCII/RTU D-Sub 9 connector (female)
- RS-485 (Modbus Master) and RS-485 Modbus Slave	baud rate: 300...256000 bit/s transmission mode: ASCII/RTU connector D-Sub 9
- Ethernet	10 Base-T, Socket RJ45, WWW and FTP Server, Modbus TCP Slave
- USB	V.1.1 Device, Socket USBB-G
<b>Supplying outputs for external object devices</b>	2 x 24 V d.c., 30 mA
<b>General recorder parameters:</b>	
- frontal face dimensions	144 x 144 mm
- length behind the panel	155 mm
- panel cut-out dimensions	138 <sup>+1</sup> x 138 <sup>+1</sup> mm
- weight	ca 2 kg
- colour graphical screen	LCD 5.7" of TFT type, 320 x 240 pixels with a touch screen

- external data carrier	CompactFlash up to 4GB
- internal RAM memory (buffer)	6 MB
- built-in operators and functions	arithmetical, logic, integral
- working temperature	0... <u>23</u> ...50°C
- related air humidity	< 75% (without condensation)
- supply voltage	90... <u>230</u> ...253 V a.c.
▪ <b>Power consumption (max)</b>	< 30 VA
▪ <b>Housing protection class:</b>	
- from frontal side	IP65, acc. to EN 60529
- from terminal side	IP20, acc. to EN 60529
▪ <b>Operational safety:</b>	acc. to EN 61010-1
- installation category	II
- pollution level	2
▪ <b>Electromagnetic compatibility:</b>	
- noise emissions	acc. to EN 61000-6-4
- noise immunity	acc. to EN 61000-6-2

## 11. ORDER CODES

<b>KD7 SCREEN RECORDER - X</b>		X	X	X	X	X	X	X	X	X	X
<b>Measuring inputs (Slot 1):</b>											
without measuring inputs	0										
6 programmable measuring inputs	1										
6 standard measuring inputs 0..10V,	2										
6 standard measuring inputs 0..20mA,	3										
6 standard measuring inputs 4..20mA,	4										
6 standard measuring inputs : 3 × 0..10V + 3 × 0..20mA	5										
6 standard measuring inputs : 3 × 0..10V + 3 × 4..20mA	6										
3 programmable measuring inputs	7										
<b>Measuring inputs (Slot 2):</b>											
Without measuring inputs	0										
6 programmable measuring inputs	1										
6 universal measuring inputs ... <sup>1)</sup>	2..6										
3 programmable measuring inputs	7										
<b>Interface measuring input:</b>											
With RS-485(1) interface measuring input											1
<b>Digital signals/analog outputs (Slot 3):</b>											
Without digital signals and analog outputs											0
8 alarms (NO relay) + 8 alarms (OptoMOS)											1
8 alarms ( NC relay) + 8 alarms (OptoMOS)											2
8 digital inputs + 4 analog outputs 0..5 mA											3
8 digital inputs + 4 analog outputs 0..20 mA											4
8 digital inputs + 4 analog outputs 4..20 mA											5
8 digital inputs + 4 analog outputs 0..5 V											6
8 digital inputs + 4 analog outputs 0..10 V											7
<b>Digital signals/analog outputs (Slot 4):</b>											
Without digital signals and analog outputs											0
8 alarms (NO relay) + 8 alarms (OptoMOS)											1
8 alarms (NC relay) + 8 alarms (OptoMOS)											2
8 digital inputs + 4 analog outputs... <sup>2)</sup>											3..7
<b>Interfaces:</b>											
USB											1
USB + Ethernet + RS-485(2)											2
USB + Ethernet + RS-232											3
<b>Memory for measuring data:</b>											
With a 4GB CF card											6
As per order											X
<b>Supply:</b>											
90...253 V a.c, 90...300 V d.c.											1
18...30 V d.c.											2
<b>Recorder firmware:</b>											
Without mathematical functions <sup>3)</sup>											0
With mathematical functions											1
<b>Software servicing the recorder from PC:</b>											
KD Connect, KD Check											1
KD Connect, KD Check, KD Archive, KD7 Setup											2
<b>Acceptance tests:</b>											
Without extra requirements											8
With an extra quality inspection certificate											7
With calibration certificate											4
Acc. to customer's request											X

- 1) Write the range code from the item 2...6 as above: (Slot 1)
- 2) Write the range code from the item 3...7 as above: (Slot 3)
- 3) A key for the activation of mathematical functions can be ordered separately

## **12. MAINTENANCE AND GUARANTEE**

The KD7 recorder does not require any periodical maintenance.  
In case of some incorrect operations:

### **1. After the dispatch date and within the period stated in the guarantee card**

One should return the instrument to the Manufacturer's Quality Inspection Dept.  
If the instrument has been used in compliance with the instructions, the  
Manufacturer warrants to repair it free of charge.  
The disassembling of the housing causes the cancellation of the granted guarantee.

### **2. After the guarantee period:**

One should send the instrument to repair it in an authorized service workshop.  
Spare parts are available for the period of five years from the date of purchase.

<p><b>Our policy is one of continuous improvement and we reserve the right to make changes in design and specifications of any products as engineering advances or necessity requires and revise the above specifications without notice.</b></p>
---



**KD7-09M/1**

**LUMEL**  
EVERYTHING COUNTS



**LUMEL S.A.**

ul. Sulechowska 1, 65-022 Zielona Góra, POLAND  
tel.: +48 68 45 75 100, fax +48 68 45 75 508  
[www.lumel.com.pl](http://www.lumel.com.pl)

**Export department:**

tel.: (+48 68) 45 75 139, 45 75 233, 45 75 321, 45 75 386  
fax.: (+48 68) 32 54 091  
e-mail: [export@lumel.com.pl](mailto:export@lumel.com.pl)