

User Guide

Wallbox

CATALOG

Product Introduction

- I 01. Relative Accessories of Mode A
 - Mode A Station Overview
 - Mode C Station Overview

Parameters & Cautions

- II 03. Technic Parameters
- 04. General Charging Sketch

Instructions for Use

- III 05. Instruction for Use
- 06. Illustration of Screen
 - About Maintaining

Caution & Security

- IV 07. Caution of Using
- 08. Security Warning
- 09. Overhaul

01 Wallbox Overview

Relative Accessories of Mode A



Mode A Station Overview

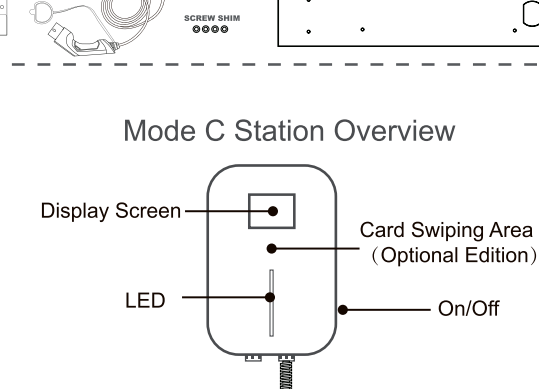

02 Wallbox Overview

Relative Accessories of Mode C

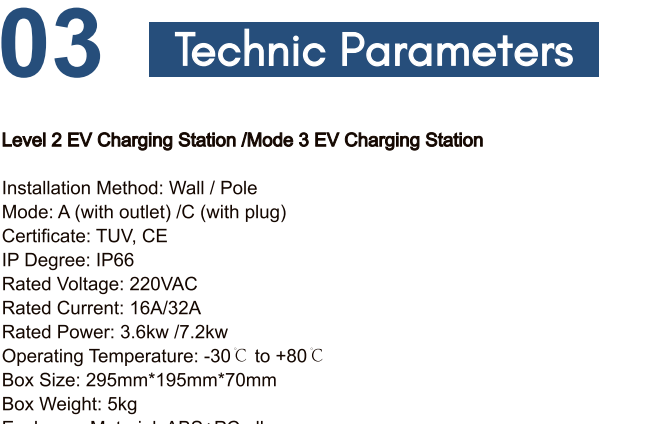

Mode C Station Overview

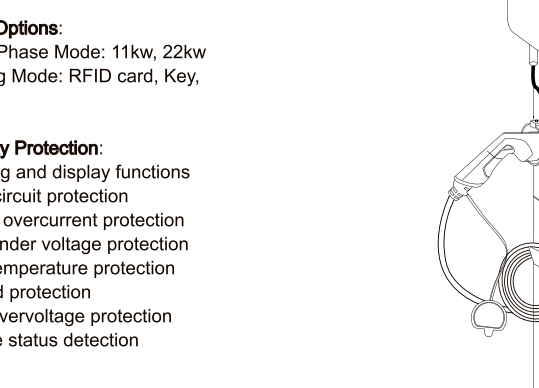

03 Technic Parameters

Level 2 EV Charging Station / Mode 3 EV Charging Station

Installation Method: Wall / Pole
 Mode: A (with outlet) / C (with plug)
 Certificate: TUV, CE
 IP Degree: IP66
 Rated Voltage: 220VAC
 Rated Current: 16A/32A
 Rated Power: 3.6kw / 7.2kw
 Operating Temperature: -30 C to +80 C
 Box Size: 295mm*195mm*70mm
 Box Weight: 5kg
 Enclosure Material: ABS+PC alloy
 Starting Mode: Button (default)
 Current Adjustable: Optional

Other Options:
 Three Phase Mode: 11kw, 22kw
 Starting Mode: RFID card, Key.

Security Protection:
 Warning and display functions
 Open circuit protection
 Output overcurrent protection
 Input under voltage protection
 Over temperature protection
 Ground protection
 Input overvoltage protection
 Charge status detection

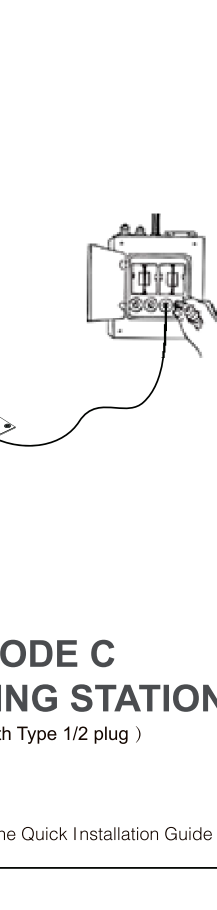

04 General Charging Sketch

MODE A CHARGING STATION (with Type 2 outlet)

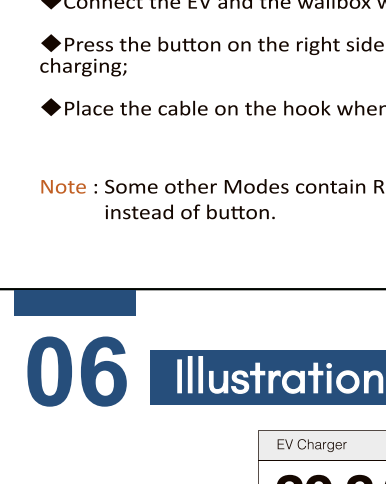

MODE C CHARGING STATION (with Type 1/2 plug)

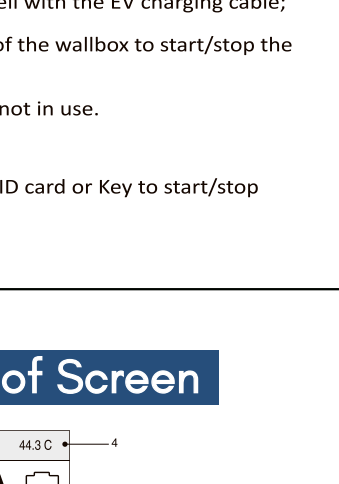

Note : The detailed installation procedure can be found the Quick Installation Guide

05 Instruction for Use

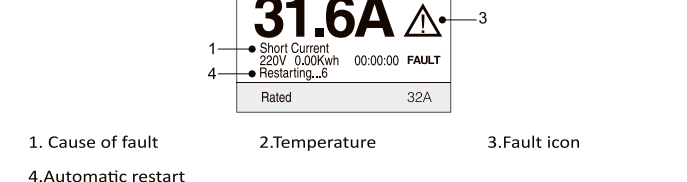

Make sure the wallbox is connected with the power already

Connect the EV and the wallbox well with the EV charging cable

Press the button on the right side of the wallbox to start/stop the charging

- ◆ Make sure the wallbox is connected with the power already;
- ◆ Connect the EV and the wallbox well with the EV charging cable;
- ◆ Press the button on the right side of the wallbox to start/stop the charging;
- ◆ Place the cable on the hook when not in use.

Note : Some other Modes contain RFID card or Key to start/stop instead of button.

06 Illustration of Screen

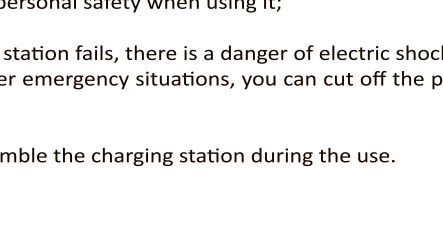

- 1. Real-time current
- 2. Real-time voltage
- 3. Charge amount
- 4. Temperature
- 5. Charging time
- 6. Charging time
- 7. Rated current

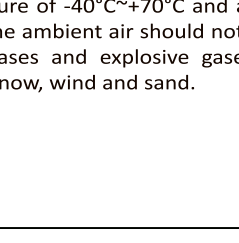

- 1. Cause of fault
- 2. Temperature
- 3. Fault icon
- 4. Automatic restart

Note : When a simple problem like short current occurs, the wallbox will automatically restart the repair and continue charging.

About Maintenance

In order to ensure the normal service life of the charging station and reduce the use risk, maintenance must be performed within the specified time; the maintenance of the equipment needs to be completed by professionals, and the use of qualified and safe maintenance tools.

07 Caution of Using

- ◆ Failure to follow instructions may result in danger;
- ◆ Please use the charging stand only if it is in accordance with the normal operation of the technology and safe operation;
- ◆ Children are prohibited from touching charging station;
- ◆ Install a charging station away from pyrotechnics, dust and corrosive occasions;
- ◆ The output of the charging station is high pressure, and you must pay attention to personal safety when using it;
- ◆ If the charging station fails, there is a danger of electric shock and even death. Under emergency situations, you can cut off the power supply;
- ◆ Do not disassemble the charging station during the use.

The product is already packed in the factory, and during transportation, strong impact and bumps should be avoided to avoid damage to the outer packaging of the product. The product should be placed at an ambient temperature of -40°C~+70°C and a relative humidity of no more than 95%. The ambient air should not contain acids, alkalis or other corrosive gases and explosive gases, and it should be protected from rain, snow, wind and sand.

08 Security Warning

Failure to follow instructions may result in danger!

- ▲ Regularly check whether the charging station has visible damage, and there may be a electric shock hazard when operating the damaged charging station;
- ▲ Make sure that all safety facilities are available at all times and test regularly to ensure proper operation;
- ▲ If a ground fault occurs, it must be assumed that the base's cable carries the voltage, and after confirming that no high-voltage power is available in the system, the charging station is inspected.
- ▲ Persons who install and use charging poles must observe the principles and regulations to ensure the personal safety and equipment safety of the personnel concerned.
- ▲ Before powering on the device, please confirm that the device is properly grounded to avoid unnecessary accidents.
- ▲ All tools used do not need exposed metal parts should be insulated to prevent exposed metal parts from touching the metal frame, causing a short circuit
- ▲ Do not modify, retrofit, or change any part by yourself under any circumstances.
- ▲ Ensure the service life and operation of the charging pile are stable, and the environment for use of the equipment should be kept as clean, constant temperature and humidity as possible. The charging pile must not be used in the presence of volatile gas or flammable atmosphere.
- ▲ Be sure to confirm that the input voltage, frequency, circuit breakers and other conditions of the device have already met the specifications before the device is powered on.

09 Overhaul

AC charging stations are subject to stringent quality inspections. From the day of purchase, any quality problems caused by using the equipment correctly within a year can be reflected to the dealer for the after-sales service.

Any incorrectness to handle, install, misuse, repair or neglect caused by the user's own inaccuracy or any natural damage resulting in direct damage and failure to the product cannot be covered by the warranty.

This quality guarantee is only for original buyers.

LUMEL S.A.
 ul. Sulechowska 1, 65-022 Zielona Góra, POLAND
 tel.: +48 68 45 75 100, fax +48 68 45 75 508
 www.lumel.com.pl

Export department:
 tel.: (+48 68) 45 75 139, 45 75 233, 45 75 321, 45 75 386
 fax.: (+48 68) 32 54 091
 e-mail: export@lumel.com.pl